

aquaform

well-being through water

aquaform

well-being through water

INDEX / *INDICE*

ABOUT US / <i>CHI SIAMO</i>	04
INSPIRATION/ <i>ISPIRAZIONE</i>	10
TECHNOLOGY/ <i>TECNOLOGIA</i>	16
EMOTION / <i>EMOZIONE</i>	34
APPLICATIONS / <i>APPLICAZIONI</i>	44
COLLECTIONS / <i>COLLEZIONI</i>	90

ABOUT US

/ Chi siamo

A company with thirty years of experience, aquaform offers a wide range of showerheads applied to the private and professional wellness sector. Thanks to a tireless passion and an incomparable competence, our shower models are among the most desirable found on both national and international markets, thanks to their innovation and care for details.

Azienda con esperienza trentennale, aquaform propone una vasta gamma di prodotti doccia dedicati al wellness professionale e privato. Grazie a una passione costante e a una competenza impareggiabile, i nostri modelli doccia sono tra i più richiesti e venduti sul mercato nazionale e internazionale, tanto da diventare best-sellers e punti di riferimento per innovazione e cura del dettaglio.

MADE
ITALY

We develop professional products and water management control systems with a specific approach oriented to professional and private wellness spaces.

Sviluppiamo prodotti professionali e sistemi di controllo per la gestione dell'acqua con un approccio specifico per gli spazi wellness professionali e privati.



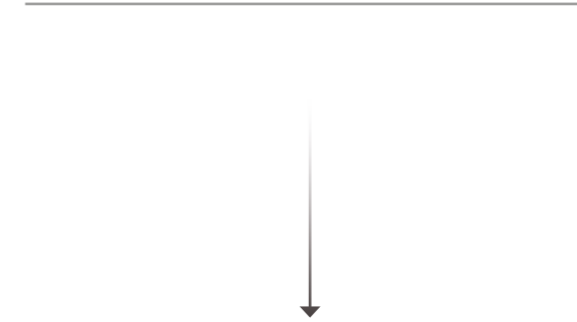

Every idea comes from a human need, which is why every product is developed with the person at the center.

Ogni idea nasce da una necessità dell'essere umano, per questo ogni prodotto è sviluppato mettendo al centro la persona.

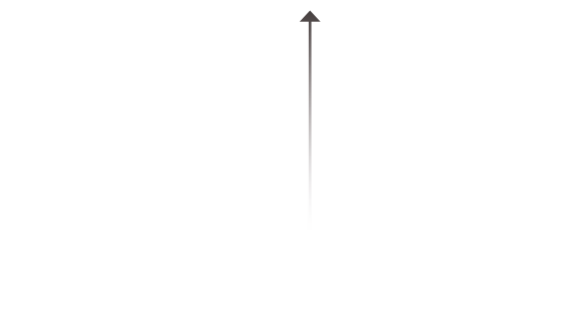

INSPIRATION

/ Ispirazione

In the form of a bursting flow or a delicate haze, water surrounds us in all its forms, as a powerful and vital natural element. aquaform proposes to recreate, through skin contact with water, the feeling of a journey through wild nature.

In forma di flusso prorompente o di bruma delicata, l'acqua ci circonda in tutte le sue forme, elemento naturale potente e vitale. aquaform propone di ricreare, tramite il contatto della pelle con l'acqua, la sensazione di un viaggio nella natura incontaminata.

Water

The touch of water on our skin comes in many forms: an enveloping cloud, the gentle touch of a drizzle or the mighty downpour of a summer storm.

Acqua

Il tocco dell'acqua sulla nostra pelle si declina in numerose forme: una nuvola avvolgente, il dolce tocco di una pioggerella o il possente flusso di un temporale estivo.

Air

The fragrance of the wet soil, of the moss that grows on the river depth, or the sparkling scent of a waterfall foam: precious emotions and atmospheres to recreate.

Aria

La fragranza del terreno bagnato, del muschio che cresce sul fondale, o l'odore frizzante della spuma di una cascata: preziose emozioni e atmosfere tutte da ricreare.

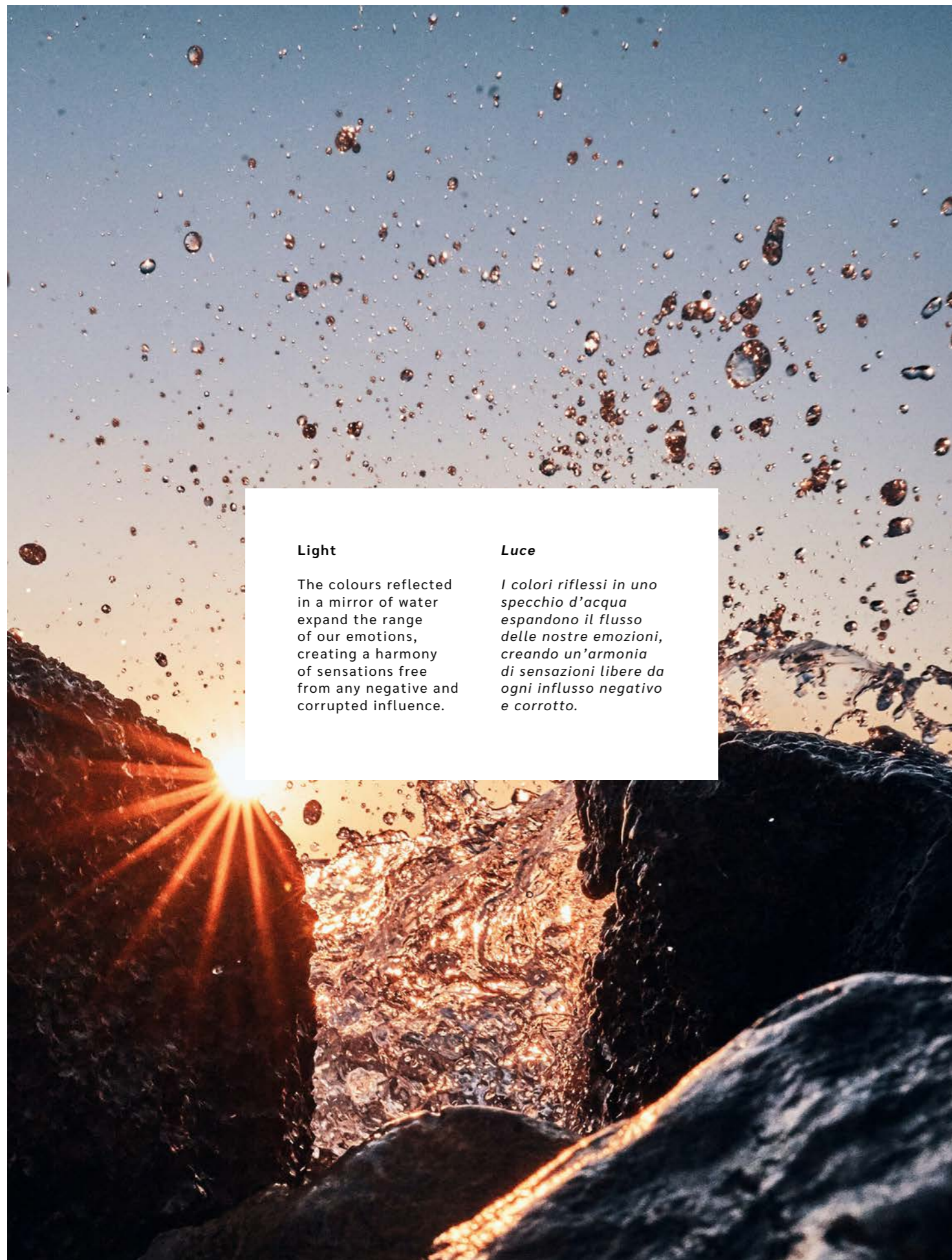

Light

The colours reflected in a mirror of water expand the range of our emotions, creating a harmony of sensations free from any negative and corrupted influence.

Luce

I colori riflessi in uno specchio d'acqua espandono il flusso delle nostre emozioni, creando un'armonia di sensazioni libere da ogni influsso negativo e corrotto.

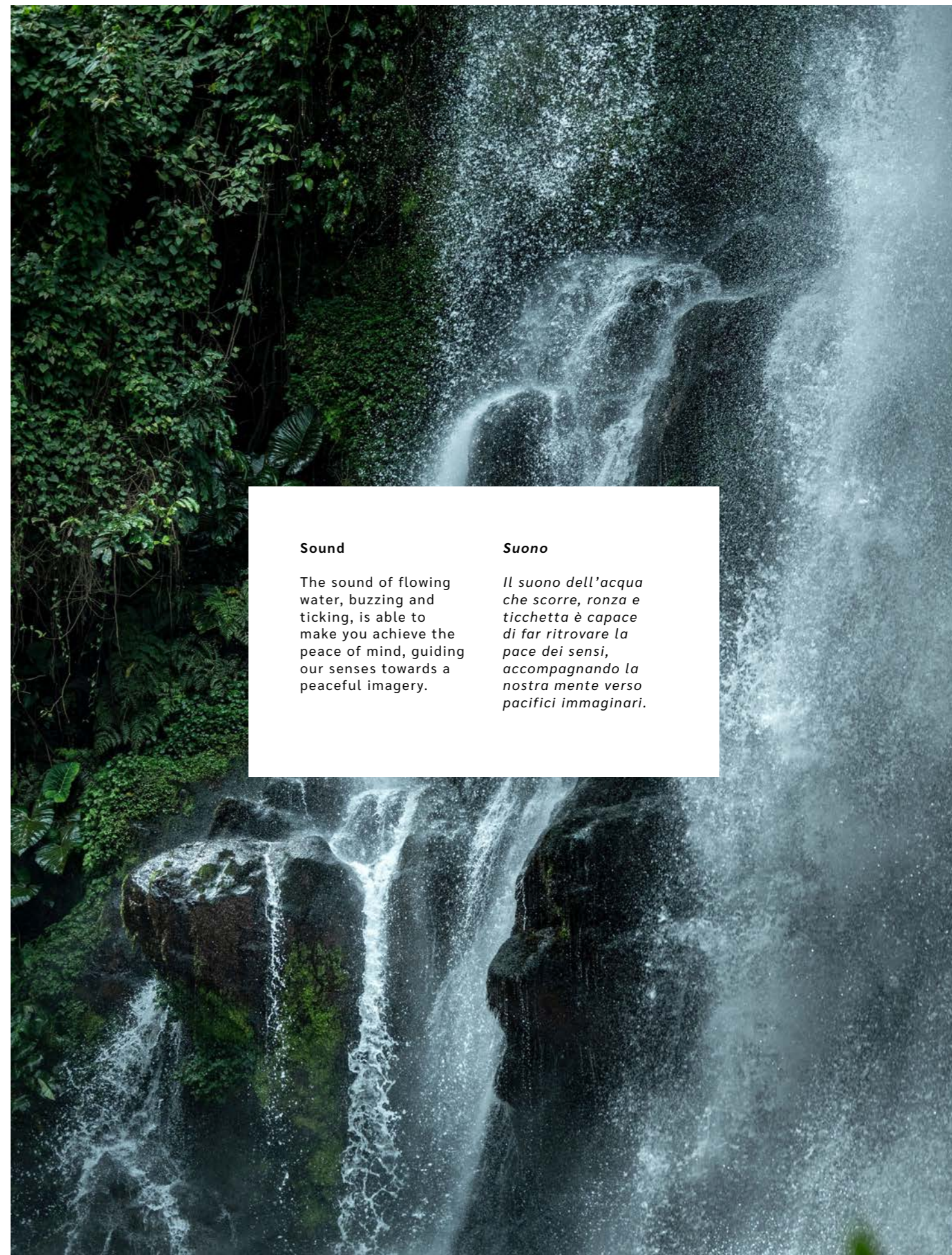

Sound

The sound of flowing water, buzzing and ticking, is able to make you achieve the peace of mind, guiding our senses towards a peaceful imagery.

Suono

Il suono dell'acqua che scorre, ronzia e ticchetta è capace di far ritrovare la pace dei sensi, accompagnando la nostra mente verso pacifici immaginari.

TECHNOLOGY

/ Tecnologia

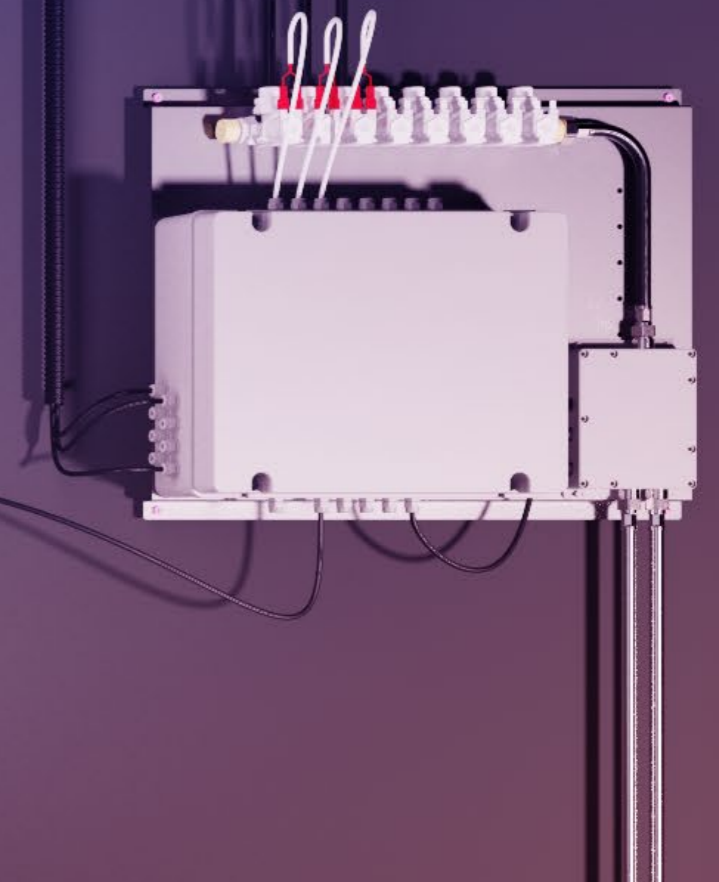

Products

/ I prodotti

Years of experience and research have led aquaform to design experiential showers with a wider wetting surface than many of our competitors, for both private and professional use. The showerheads are thinner and offer the highest levels of performance, in order to optimize the wellness experience. Finally, every single component is the result of a production and a development entirely delivered within the company and strictly made in Italy, thus guaranteeing the highest standards of quality and reliability on the market.

Anni di esperienza e di ricerca hanno portato aquaform a ideare docce esperienziali con una superficie bagnante più estesa rispetto alle comuni docce per uso privato e professionale. I prodotti sono resi più sottili e prestanti, al fine di ottimizzare l'esperienza di benessere offerta e di garantire il più alto livello di rendimento sul mercato. Ogni singola componente è frutto di un lavoro di produzione e sviluppo interno all'azienda e rigorosamente made in Italy, garantendo così i più alti standard di qualità e affidabilità sul mercato.

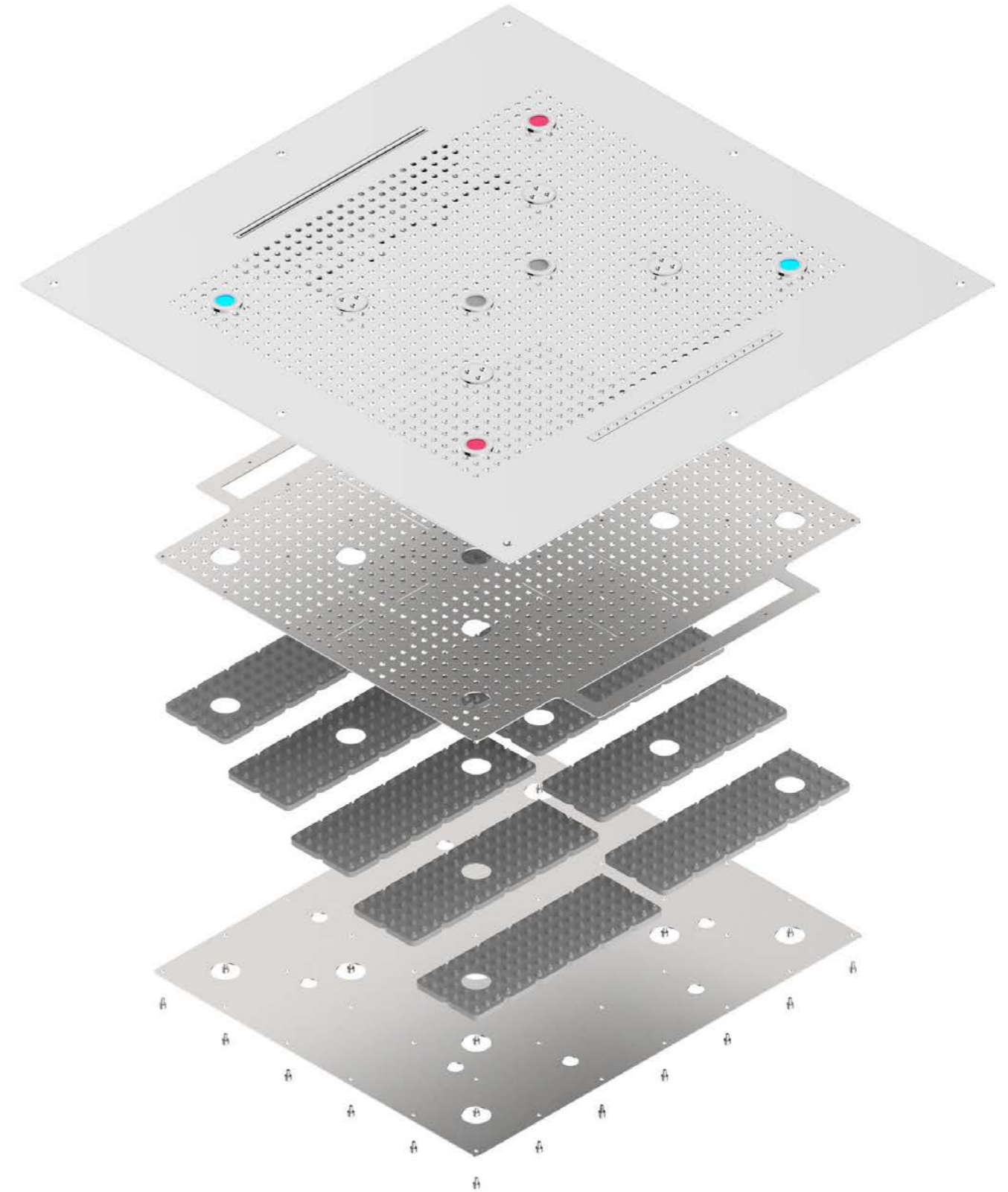
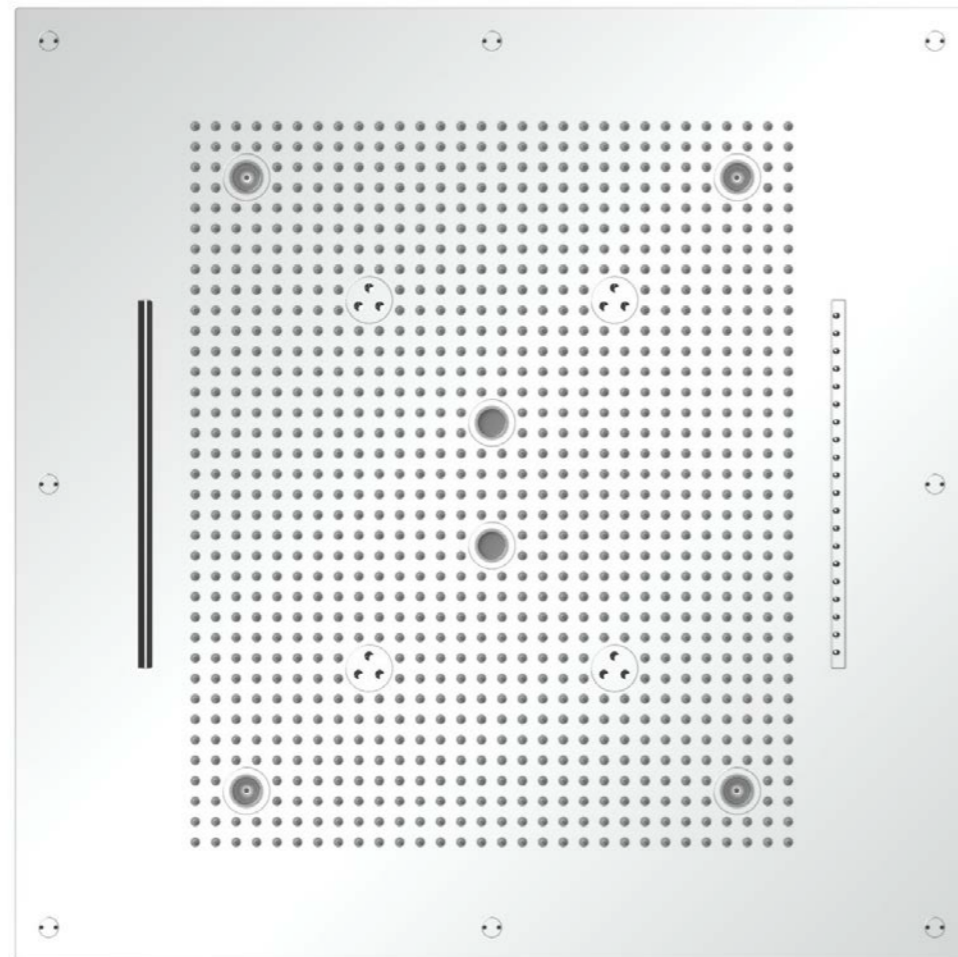

SILICONE MEMBRANES

Aquaform has developed an innovative modular system for dispensing water by using a special membrane in liquid silicone, UK Wras certified, that offers many advantages including an uniform distribution of the rain jet over the entire surface, even on large shower heads.

Anti-limescale

Uniform distribution

Less pressure and more resistance

Antibacterial

MEMBRANE IN SILICONE

Aquaform ha sviluppato un innovativo sistema modulare per l'erogazione dell'acqua utilizzando una speciale membrana in silicone liquido certificata UK Wras che permette di avere numerosi vantaggi come la distribuzione uniforme del getto pioggia su tutta la superficie anche su soffioni di grandi dimensioni.

Anticalcare

Uniformità di distribuzione

Minore pressione e maggiore resistenza

Antibatterica

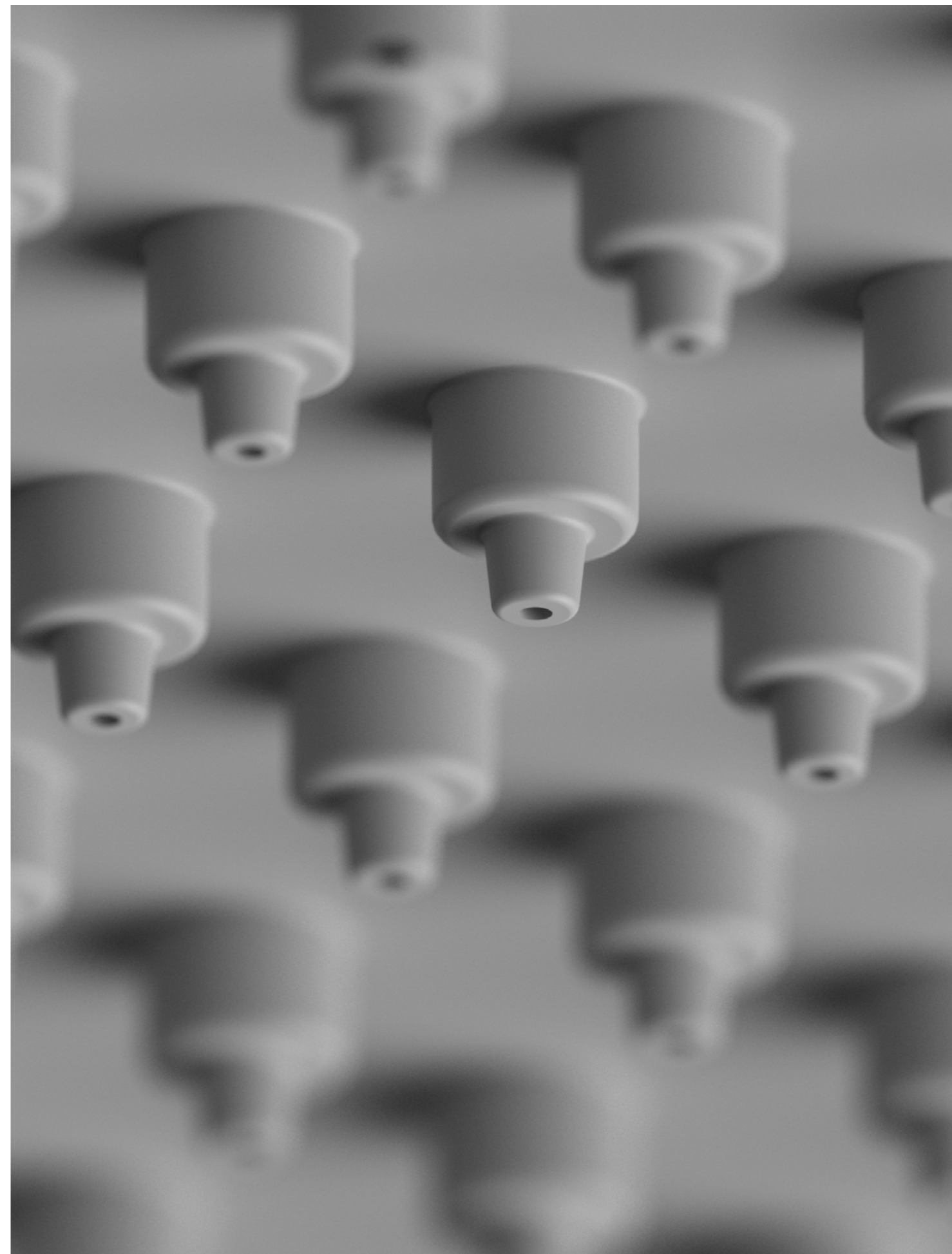
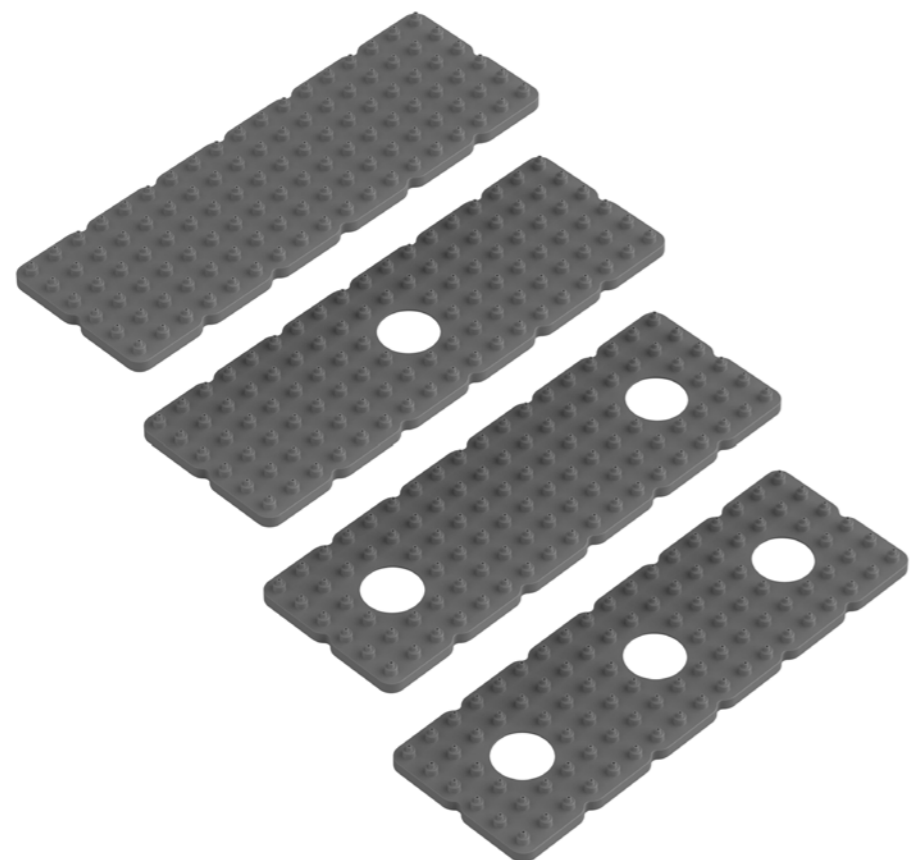

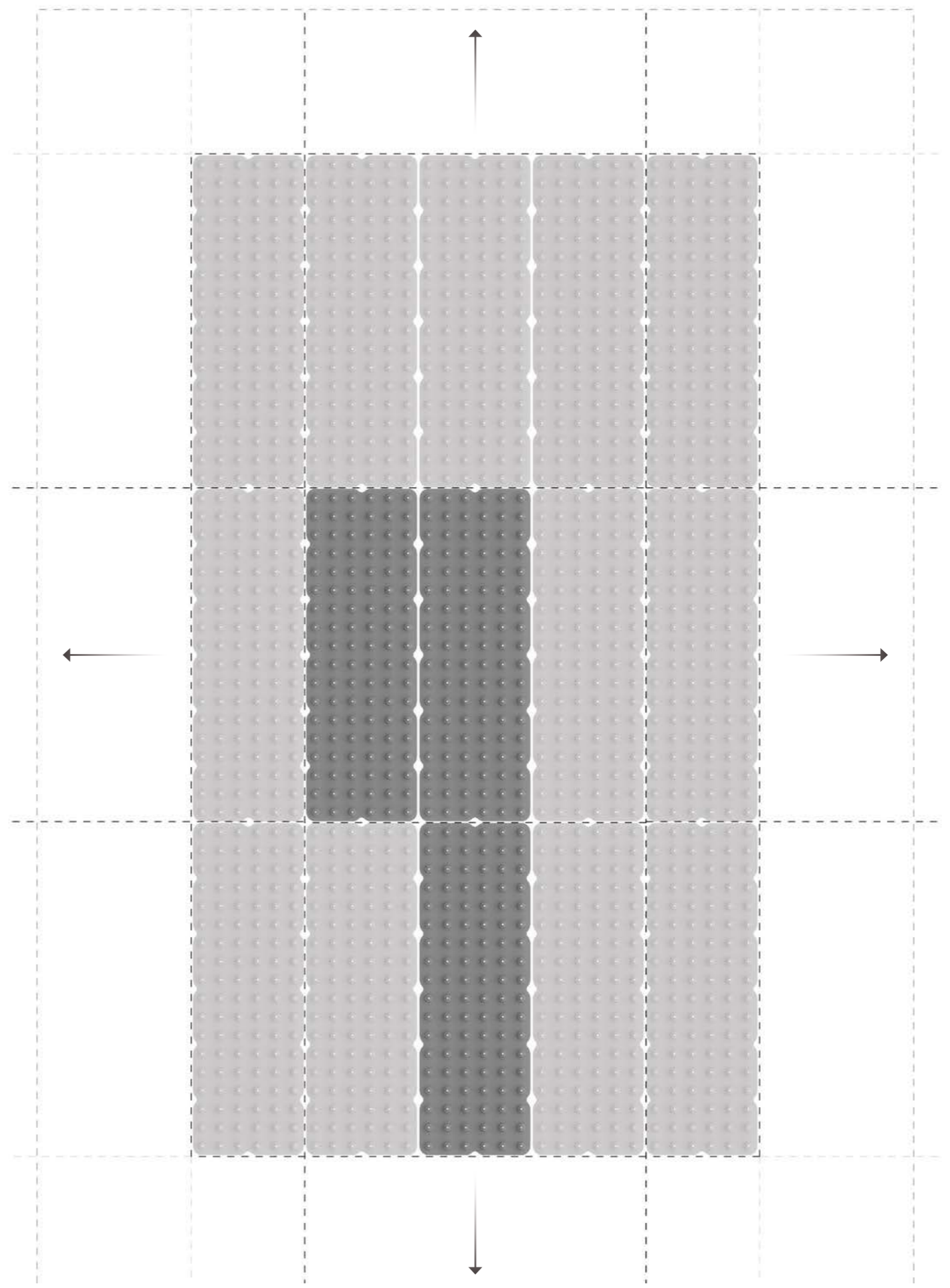
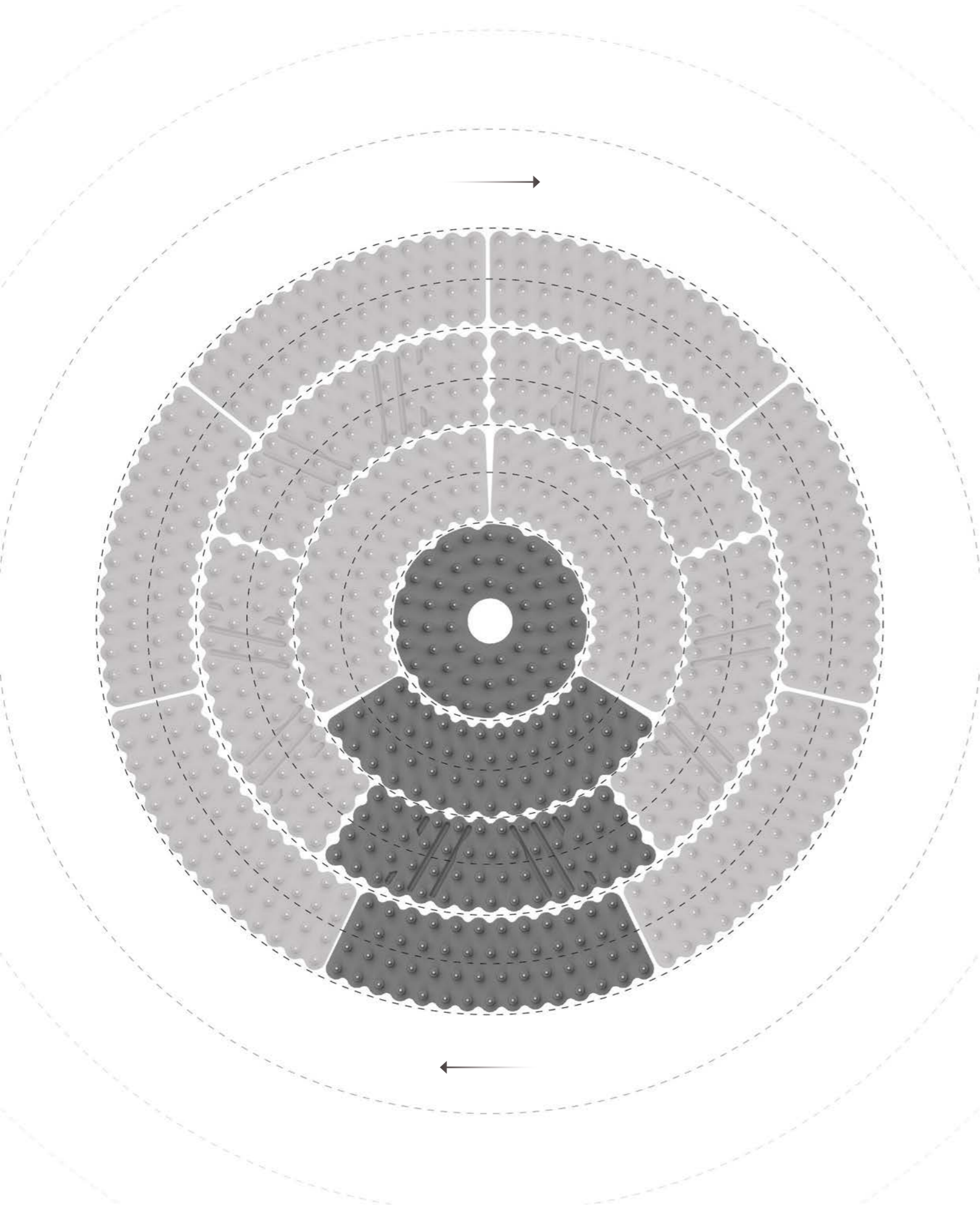

JETS

Each components is planned and designed by our R&D department to create new and exclusive styles of jet.

GETTI

Ogni singolo componente viene studiato e progettato dal nostro reparto di ricerca e sviluppo per dar vita a numerose, esclusive tipologie di getto.



SPOTLIGHT

Chromotherapy is a fundamental element of the aquaform offer. This is why we chose to design and produce the entire lighting system by using a special depth lens combined with a 3W RGB+W LED, with a 30° light beam, amplified by a PMMA optical lens that reproduces a real shower of color. These materials and characteristics allow the spotlight to withstand conditions of intensive use, such as in wellness centres or SPA, and grants a high degree of water protection (IP68). The resistance of the spotlight has been tested and certified for both electrical and photobiological safety.

Last but not least, we planned a heat sink that allows the LED to be used with no interruption for thousands of hours.

FARETTO

La cromoterapia è un elemento fondamentale della proposta aquaform. Per questa ragione abbiamo deciso di progettare e produrre interamente tutto il sistema di illuminazione Utilizzando una speciale lente di profondità' abbinata a un LED RGB+W di potenza da 3W con un fascio luminoso di 30°, amplificato da una lente ottica in PMMA ricreando una vera e propria doccia di colore. Questi materiali e queste caratteristiche permettono al faretto di resistere in condizioni di utilizzo intensivo, come nei centri benessere o termali, garantendo un alto grado di protezione all'acqua (IP68). La resistenza del faretto è stata testata e certificata sia per sicurezza elettrica che fotobiologica.

Infine, abbiamo studiato un dissipatore di calore, che permette al LED di funzionare ininterrottamente per migliaia di ore.

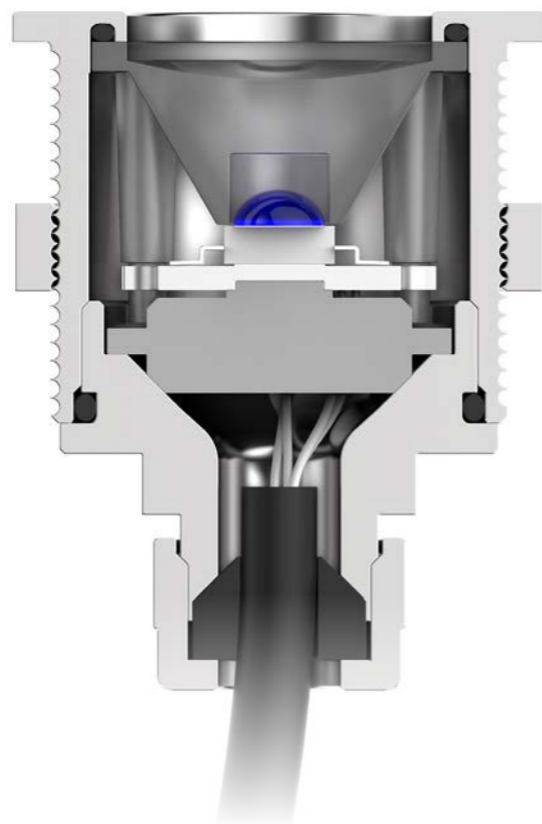

COUNTERPLATE

The entire range of shower heads is equipped with an exclusive double plate construction, one that holds the technical part and another for aesthetic purposes. They are welded together through a particular laser processing that provides many aesthetic and functional advantages.

CONTROPIASTRA

Tutti i sistemi doccia aquaform sono dotati di un esclusiva realizzazione a doppia piastra, una per contenere la parte tecnica e un'estetica, saldate tra di loro per mezzo di una particolare lavorazione laser che permette di ottenere numerosi vantaggi estetici e funzionali.

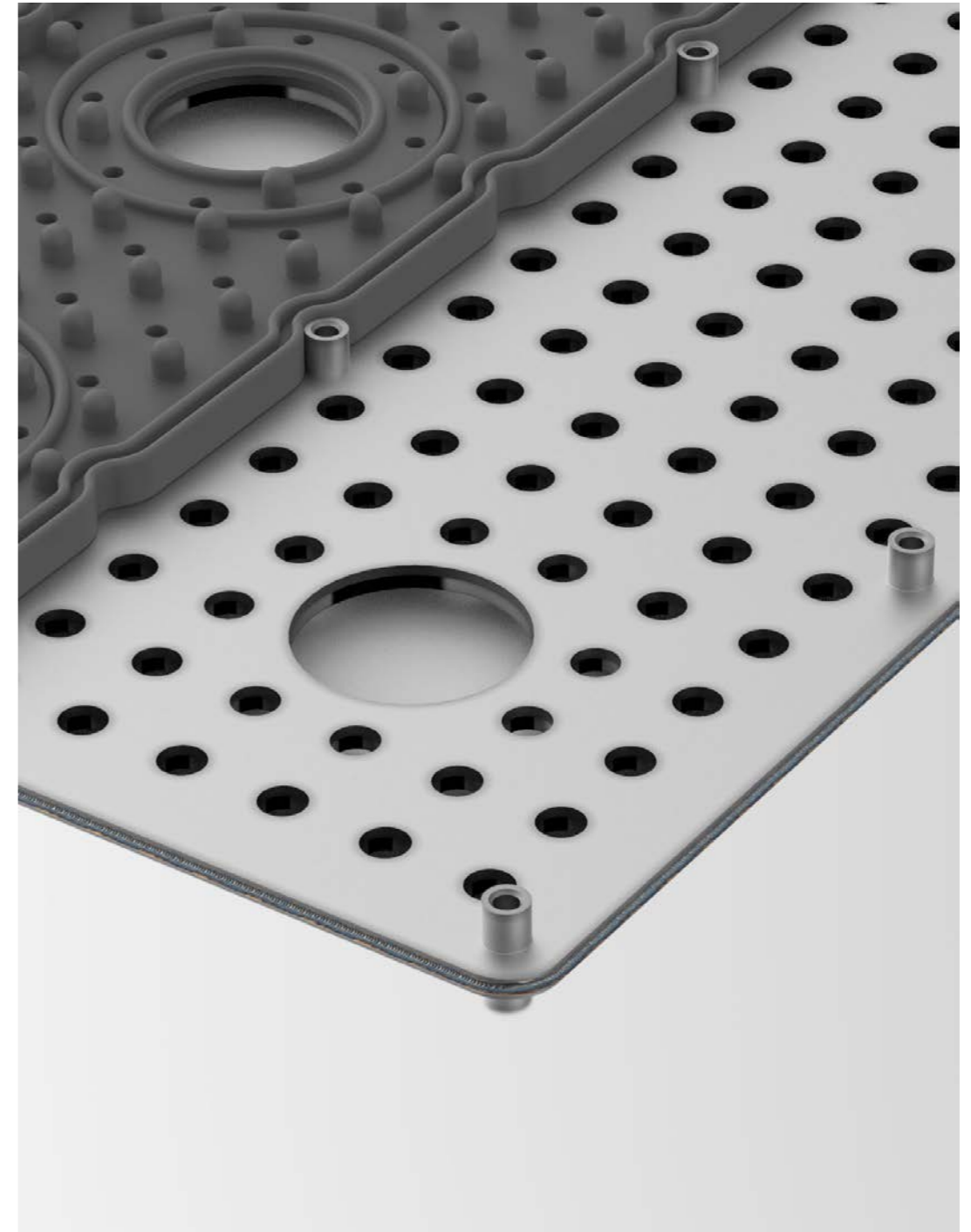
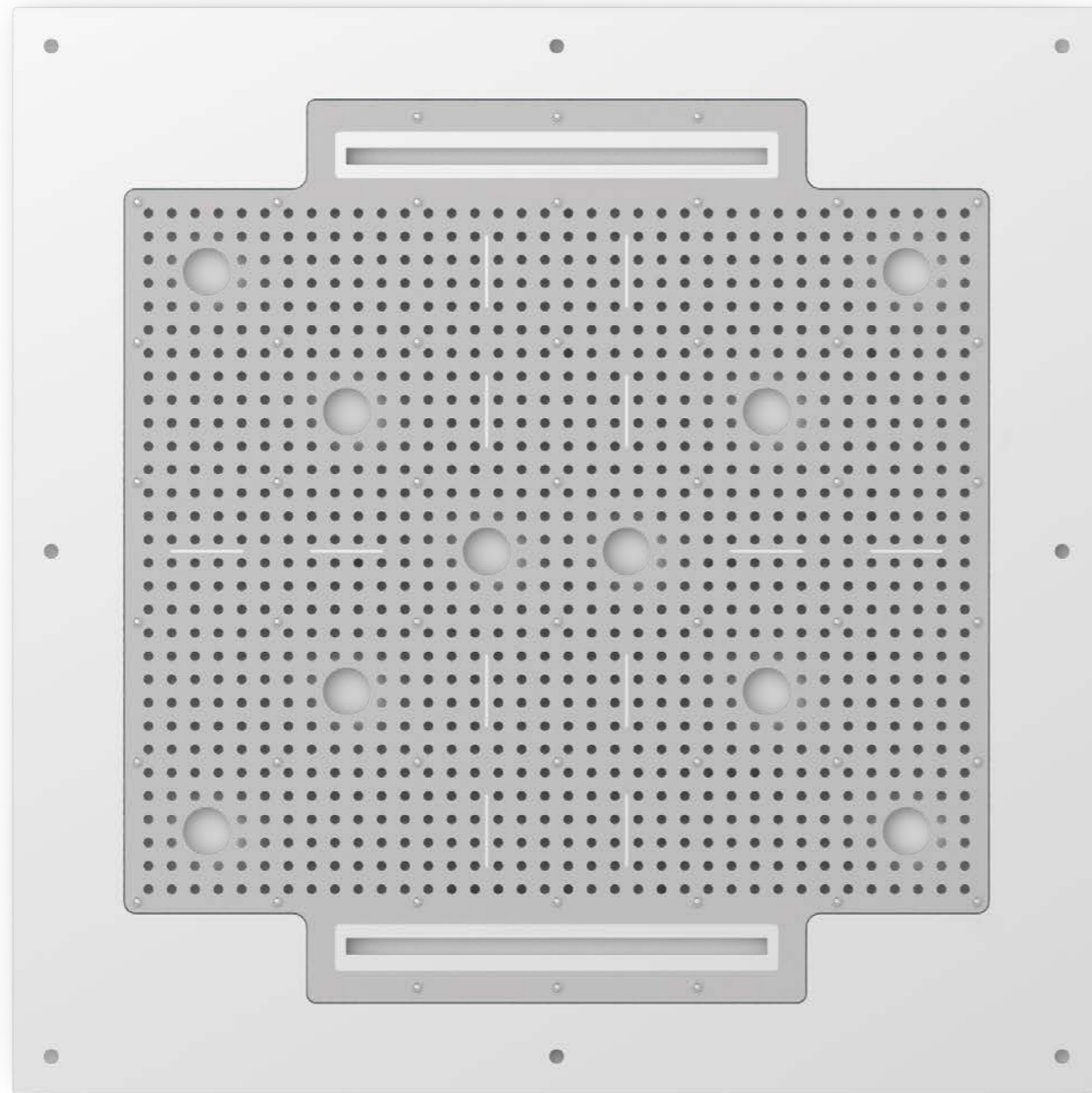

FINISHES

FINITURE

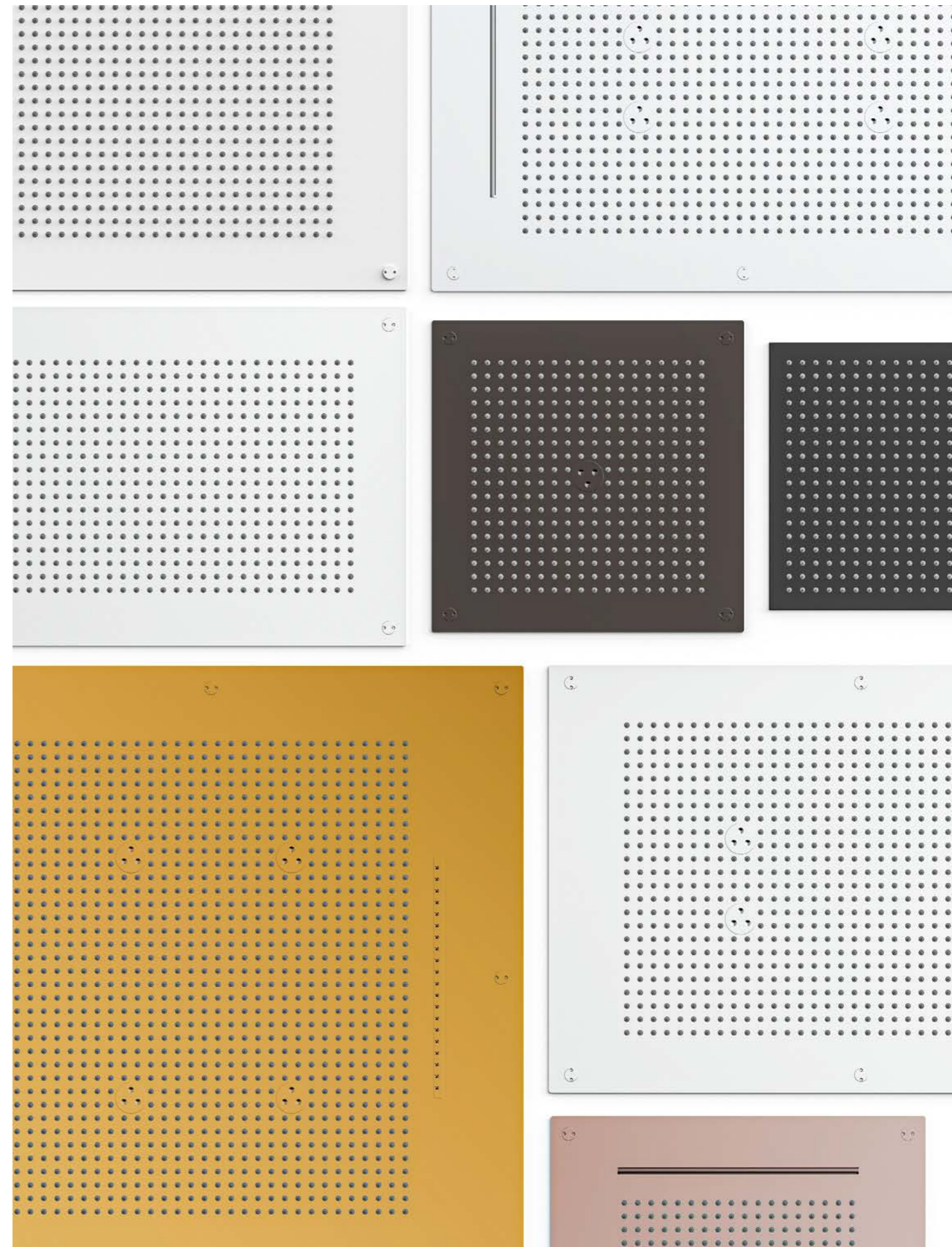
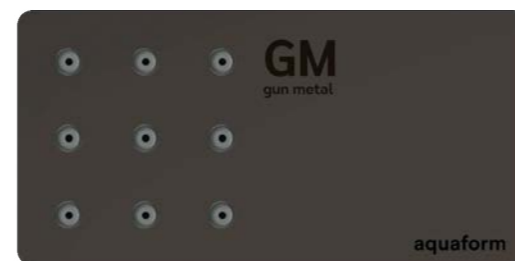
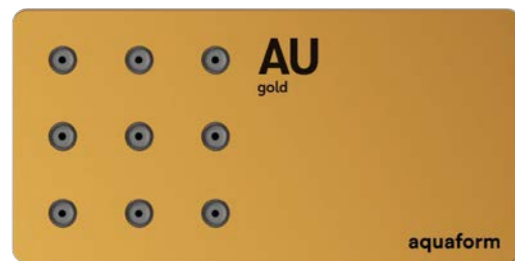
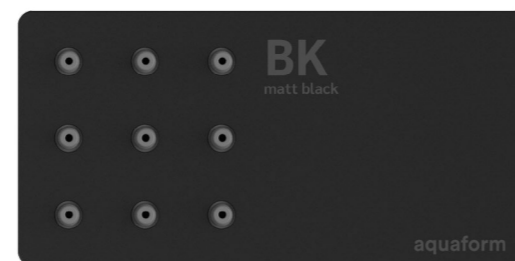
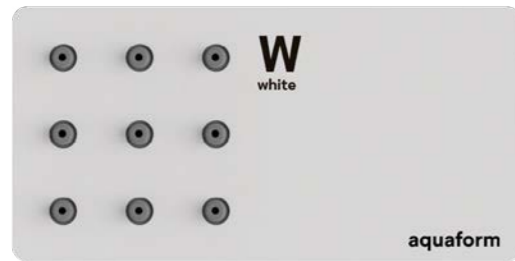
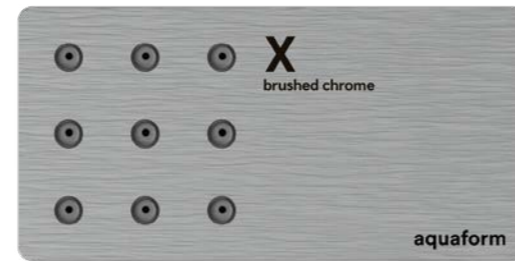
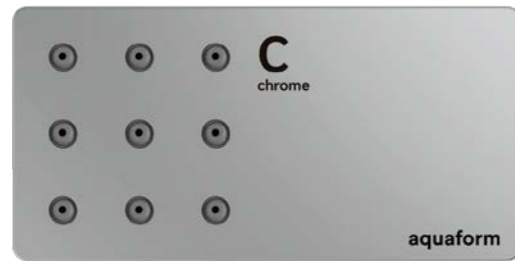

CONTROL UNIT

aquaform has planned varied control systems to manage parameters/elements of water-light-roma and music.

For each shower system we have devised up to 8 different user controls, equipped with different user interfaces.

CENTRALINA DI CONTROLLO

aquaform ha realizzato numerosi sistemi di controllo per la gestione dei parametri/elementi acqua-luce-roma e musica.

Per ogni sistema doccia abbiamo pensato fino a 8 modi diversi di gestione con diverse interfacce utente.



WATER / ACQUA

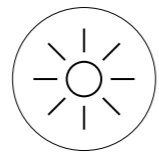

LIGHT / LUCE



AROMA / AROMA

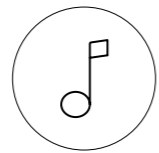

SOUND / MUSICA

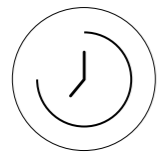

TIME / TEMPO

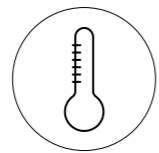

TEMPERATURE / TEMPERATURA

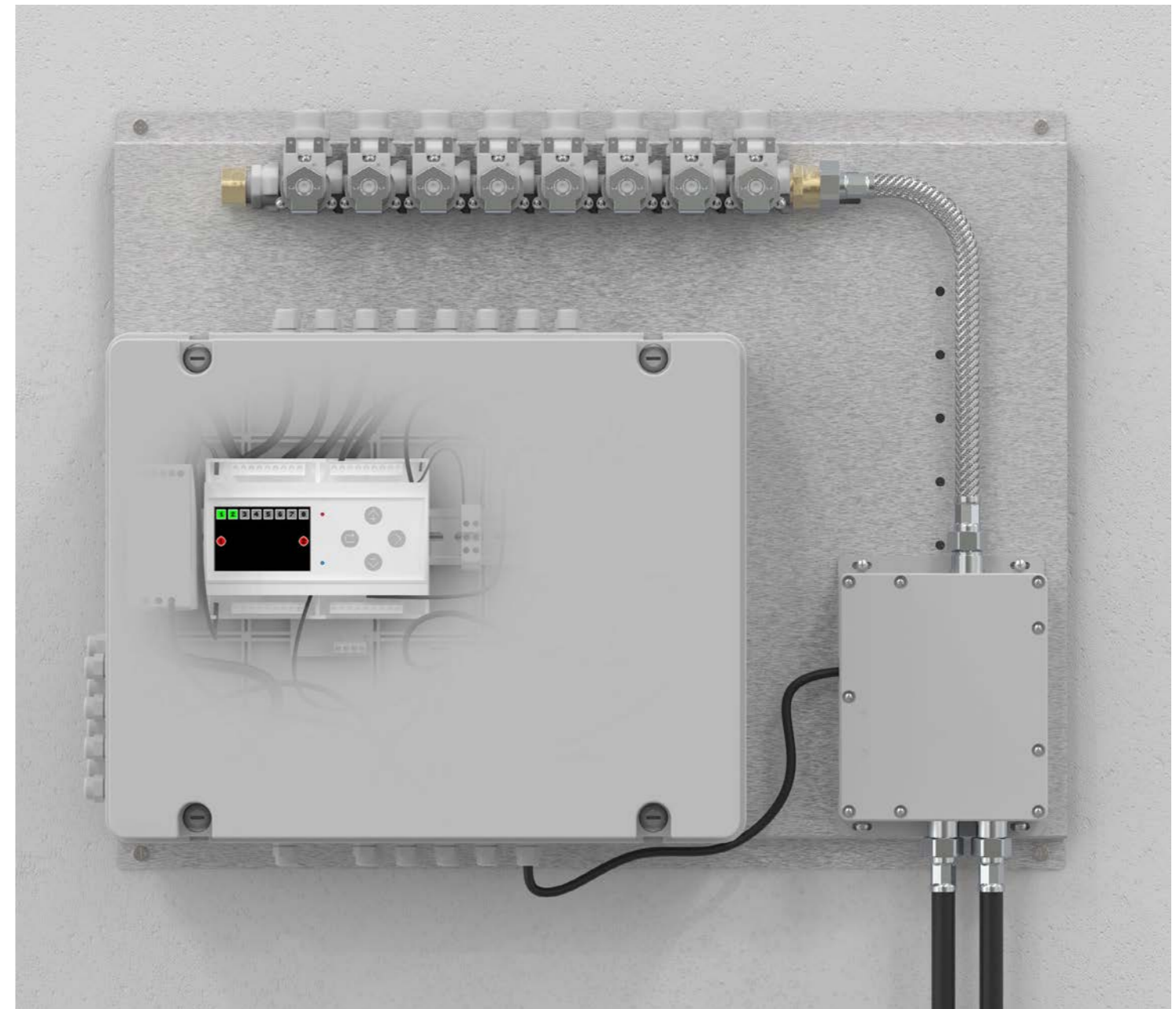

aquaform systems are simple and easy to install and intuitive to use. All systems are supplied pre-wired and 100% factory tested, thus simplifying installation.

I sistemi aquaform sono semplici e intuitivi da installare e utilizzare. Tutti i sistemi vengono forniti già pre-cablati e collaudati al 100% in fabbrica semplificando così l'installazione.

EMOTION

/ Emozione

aquaform products offer multiple combinations, designed to satisfy every need of mind and body, for a complete and targeted wellness experience.

I prodotti aquaform offrono infinite combinazioni possibili, volte a soddisfare ogni singola necessità della mente e del corpo, per un'esperienza di benessere completa e mirata.

Aquatherapy

For every tactile sensation offered by the contact with water, aquaform proposes a different jet, recreating the original sensation and recalling its sweet and powerful emotion. Each of these jets has its own soul and does not offer just a sensation, but recreates a world of atmospheres, sounds and emotions to explore and rediscover.

Acquaterapia

Per ogni sensazione tattile offerta dal contatto con l'acqua, aquaform propone un getto diverso, che ne ricrea le sensazioni originarie e ne richiama l'emozione dolce e potente. Ognuno di questi getti ha una sua anima e non propone solo una sensazione, ma ricrea un mondo di atmosfere, suoni ed emozioni differenti, da esplorare e riscoprire.

Chromotherapy

The sun refracted in water creates a rainbow: each colour of the spectrum represents a particular mood, powerful in its energetic and emotional value. The body reacts in different ways to visual stimulations: lights and colours convey electromagnetic waves that can improve our psychophysical wellness. For this reason, they become a powerful addition to our treatments, optimizing the results and guaranteeing a more complete spiritual renewal.

Cromoterapia

Il sole, rifrangendosi nell'acqua, dà origine a un arcobaleno: ogni colore dello spettro rappresenta uno stato d'animo, possente nel suo valore energetico ed emotivo. Il corpo reagisce in modi diversi a ogni stimolazione visiva: luci e colori trasmettono onde elettromagnetiche che possono migliorare il nostro benessere psicofisico. Per questo diventano una potente integrazione ai nostri trattamenti, ottimizzandone i risultati e garantendo un più completo rinnovamento spirituale.

Jets

/ Getti

Rain /
Pioggia

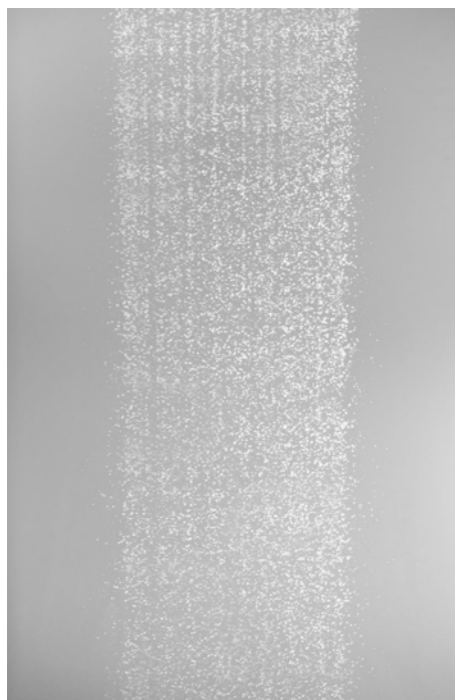

Nebulized /
Nebulizzato



LED + Nebulized /
LED + Nebulizzato



Aerated /
Aerato

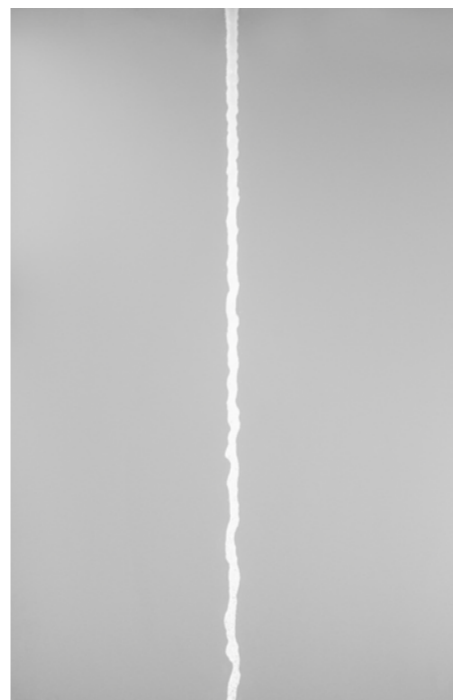

Atomized /
Atomizzato



LED + Atomized /
LED + Atomizzato

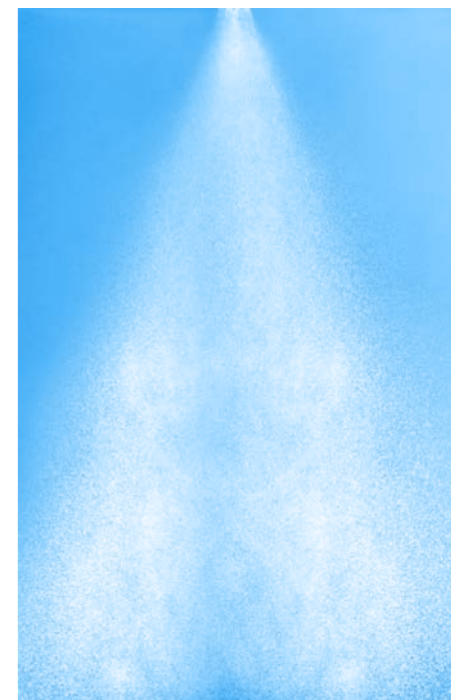

Waterfall /
Cascata



Tropical /
Tropicale



Tropical Aerated /
Tropicale Aerato



Lama /
Lama

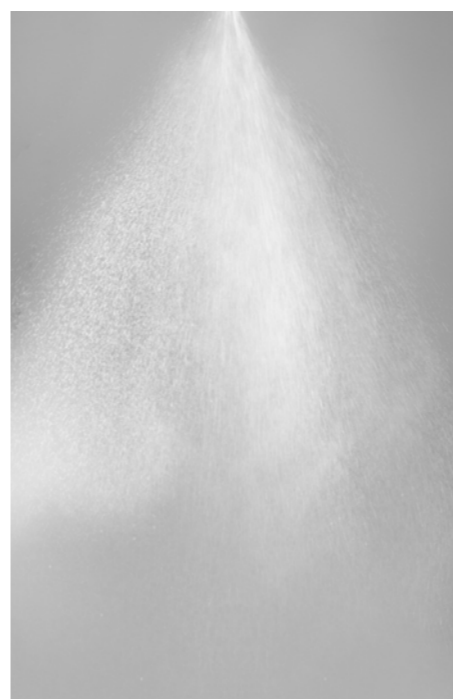

Turbine /
Turbina



Aromatherapy

With the eyes closed, every perfume is a world that opens up to our senses. Each fragrance recalls a particular scenery, acting on our nervous system and on our physical and energetic balance. The three fragrances Energy, Flowers and Relax allow you to experience three different sensorial worlds, all equally able to ensure a long-lasting feeling of relaxation and serenity.

Aromaterapia

A occhi chiusi, ogni profumo è un mondo che si apre ai nostri sensi. Ogni fragranza rievoca un particolare scenario, agendo sul nostro sistema nervoso e sul nostro equilibrio fisico ed energetico. Le tre fragranze Energy, Flowers e Relax permettono così di esperire tre mondi sensoriali differenti, ma tutti ugualmente pronti ad assicurare una sensazione di relax e serenità dalla lunga durata.

Sound

Each jet of water produces a different sound, matching different emotions and atmospheres. The ticking sound of rain, the mighty sound of a waterfall, the light whispers of a steam cloud: the sound embraces our body and removes daily stress. Combined with chromotherapy and aromatherapy, it offers a unique and universal experience, which won't fail to amaze and regenerate.

Suono

Ogni getto d'acqua provoca un suono diverso, a cui corrispondono emozioni e atmosfere differenti. Il suono ticchettante della pioggia, lo scroscio possente di una cascata, il lieve sussurro di una nuvola di vapore: il suono avvolge il corpo e lo isola dallo stress quotidiano. Abbinandosi ai sistemi di cromoterapia e aromaterapia, regala un'esperienza unica e universale, che non mancherà di stupire e rigenerare.

GUIDELINES

/ Linee guida

DRAINING / DRENANTE

30"/60"
TIME



26°C
TEMPERATURE



RAIN
JET



LIGHTBLUE
Colour



MUSCLE RELAXING / MIORILASSANTE

60"/90"
TIME



42°C
TEMPERATURE



NEBULIZED
JET



ORANGE
Colour



ENERGIZING / ENERGIZZANTE

20"/40"
TIME



24°C
TEMPERATURE



TROPICAL
JET



GREEN
Colour



SOOTHING / LENITIVO

45"/75"
TIME



40°C
TEMPERATURE



TROPICAL
AERATED
JET



PINK
Colour



DECONTRACTING / SCIOGLIENTE

60"/90"
TIME



36°C
TEMPERATURE



WATERFALL
JET



PURPLE
Colour



STIMULANT / STIMOLANTE

15"/30"
TIME



26°C
TEMPERATURE



AERATED
JET



BLUE
Colour



ENERGIZING / ENERGIZZANTE

30"/60"
TIME



38°C
TEMPERATURE



TROPICAL
JET



ORANGE
Colour



REGENERATE / RITEMPRANTE

15"/30"
TIME



20°C
TEMPERATURE



WATERFALL
JET



AQUAMARINE
Colour





APPLICATIONS

/ Applicazioni

PROFESSIONAL SPA

/ SPA PROFESSIONALI

46

PRIVATE SPA

/ SPA PRIVATE

68

TAILOR MADE

/ SPA PERSONALIZZATE

86



PROFESSIONAL SPA

/ SPA Professionali

aquaform has specialized for decades in the development of products devoted to the world of professional SPAs, we establish a partnership with bbspa&partners, international company for consulting, engineering and implementation of SPA projects, that shares with us his unique and precious know how to create, develop and guarantee to our customer all the new technologies, and wellness programs suitable to meet any audience and desire.

aquaform è da decenni specializzata nello sviluppo di prodotti dedicati al mondo delle SPA professionali e private; durante questi anni sono state strette numerose collaborazioni e partnership, specialmente con bbspa&partners, società internazionale di consulenza, ingegnerizzazione e realizzazione di progetti SPA. Abbiamo condiviso i nostri programmi e percorsi di benessere, uniti ad un prezioso ed unico know how per riuscire a creare, sviluppare e garantire la realizzazione di SPA professionali adatte ad ogni pubblico ed ogni desiderio.

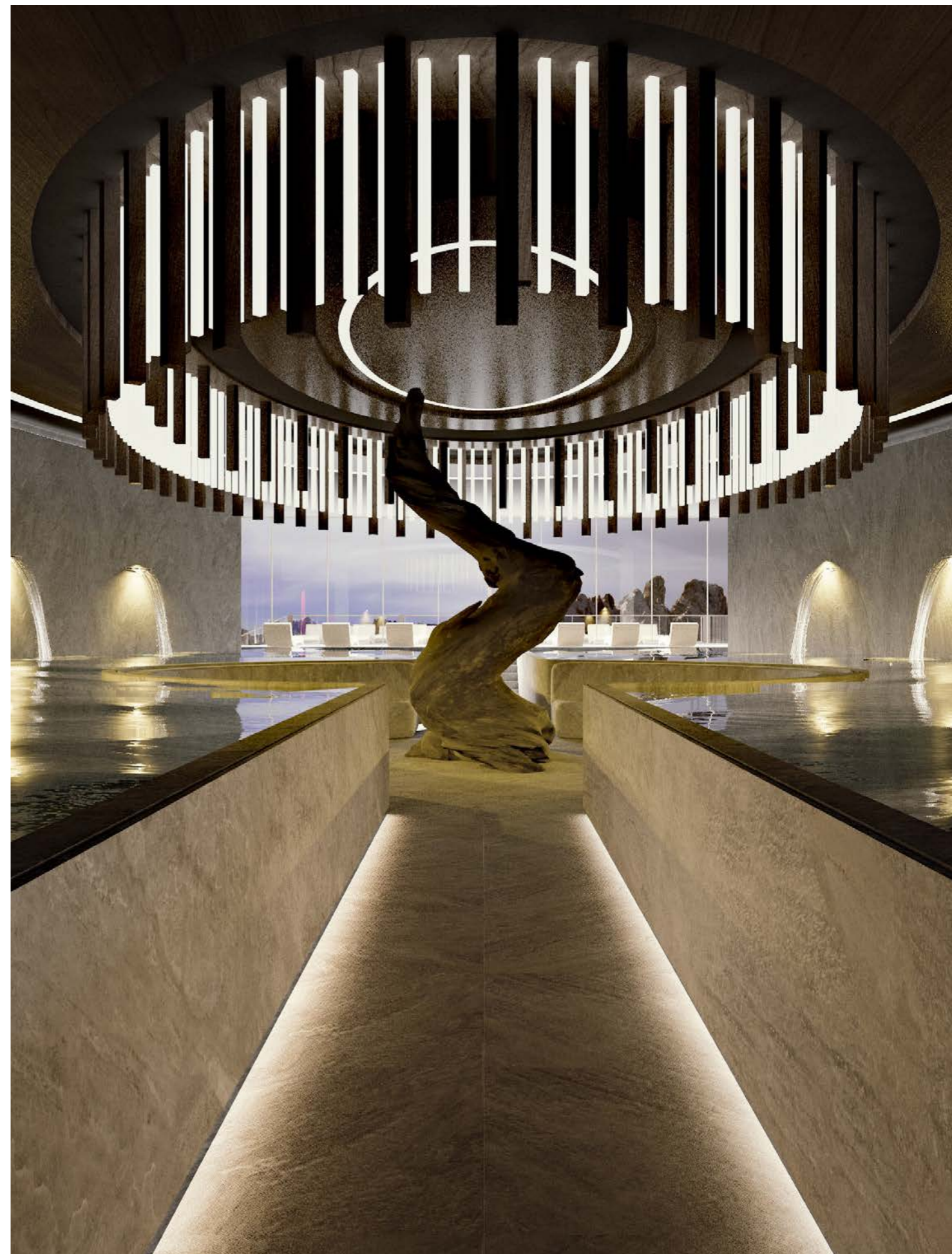

EXPERIENCE SHOWER

/ DOCCIA SENSORIALE

Experience shower with 4 types of jets and chromotherapy with 4 led RGBW Control unit for 4 different pre-set programs to achieve 4 different treatment cycles: energy - balance - sport and relax.

Doccia sensoriale con 4 tipologie di getto e cromoterapia con led RGBW completa di centralina di controllo per 4 differenti programmi pre-impostati per ottenere 4 diversi cicli di trattamento: energy - balance - sport e relax

EXPERIENCE SHOWER

AMBIENT: PUBLIC

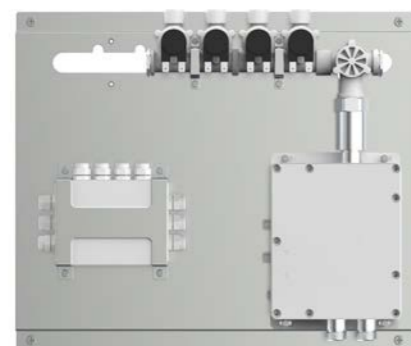
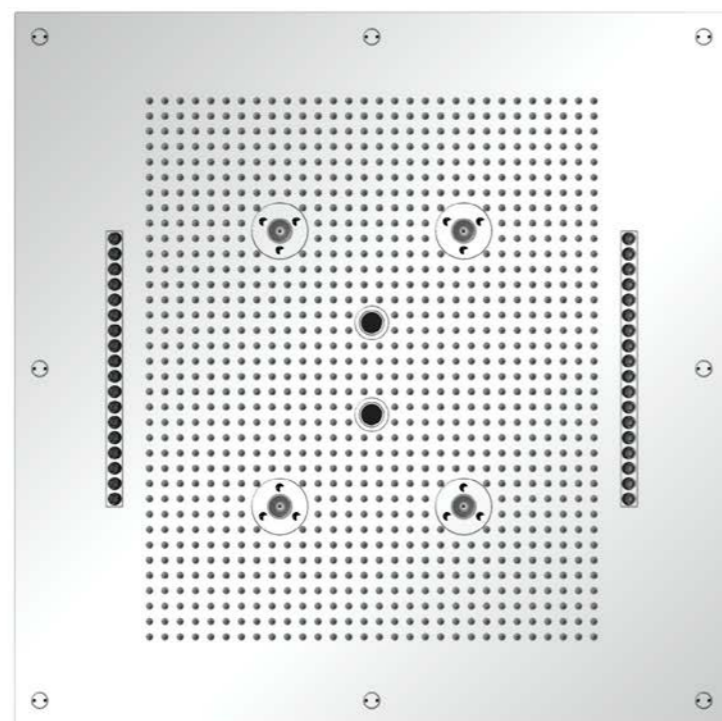

COMPONENTS / COMPONENTI

SHOWERHEAD
SENSUS R70C12L3A5

CONTROL PANEL
C48FX

FEATURES / CARATTERISTICHE



APPLICATIONS

PREDISPOSITION

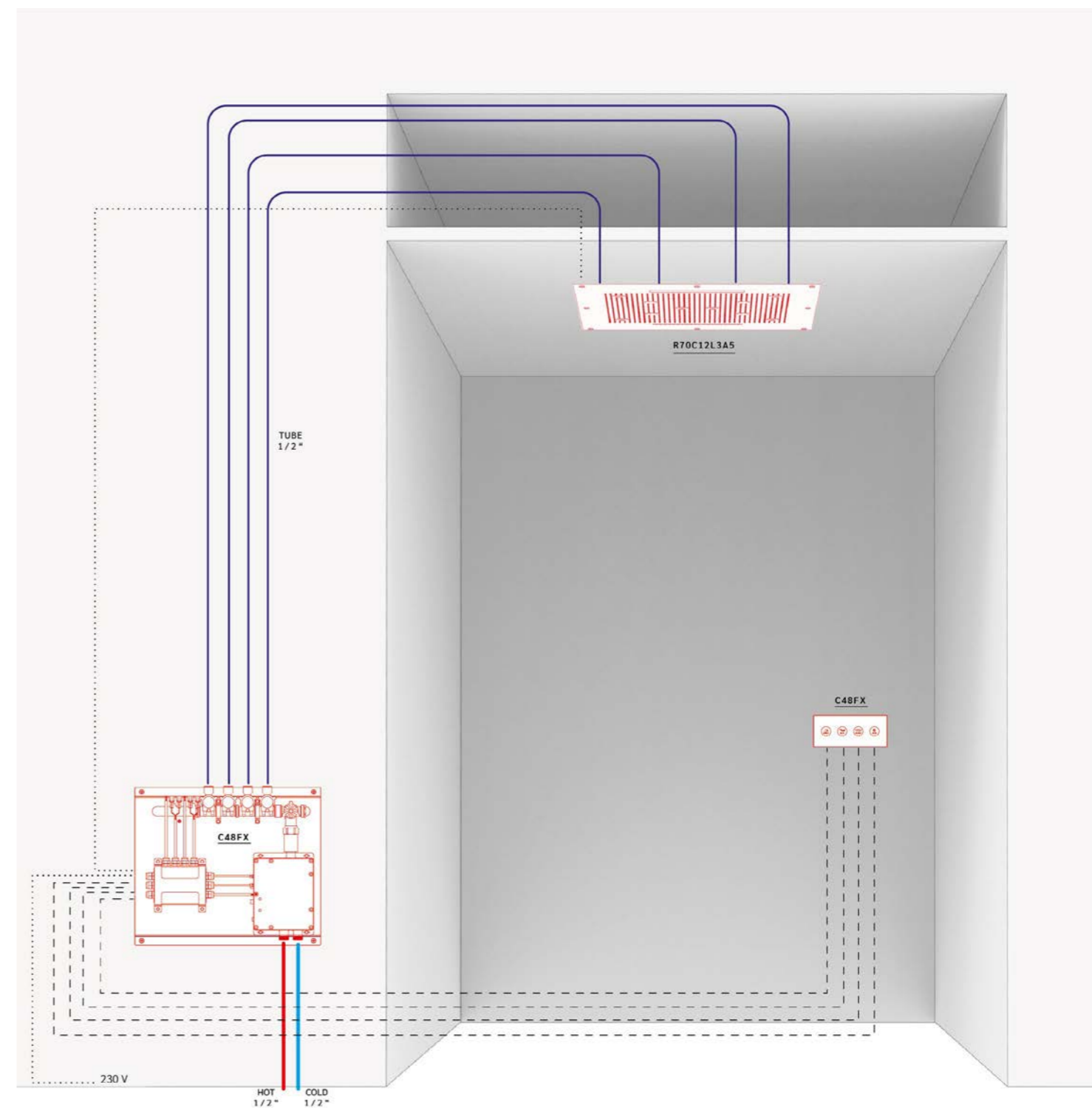

LEGEND / LEGENDA

- WATER SUPPLY 1/2"
- ELECTRICAL CABLES
CORRUGATED PIPE DIAM. 20mm
- LED CABLES DIAM. 20mm

TECHINICAL INFORMATION / INFO TECNICHE

WATER FLOW	min 30 U/m
WATER SUPPLY	1/2" inch
OPERATING PRESSURE	1,5/5 bar
RECOMMENDED PRESSURE	3 bar

KNEIPP PATH

/ PERCORSO KNEIPP

Kneipp path composed by body jets with led RGB with nebulized atomized jets completed with Professional control unit for sequential activation via single button of the experience shower. Possibility to set different parameters by selecting: times, sequence of jets, RGB lights, water temperature via electronic mixer.

Percorso Kneipp composto da body jet con led RGB con nebulizzazione e atomizzazione completo di centralina professionale per l'attivazione sequenziale tramite singolo pulsante del percorso sequenziale. Possibilità di impostare diversi parametri selezionando: tempi, sequenza dei getti, luci RGB, temperatura dell'acqua tramite miscelatore elettronico.

KNEIPP PATH

AMBIENT: PUBLIC



PREDISPOSITION

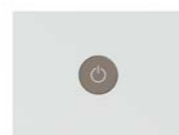
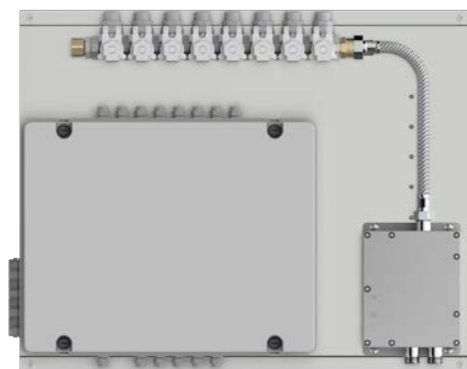
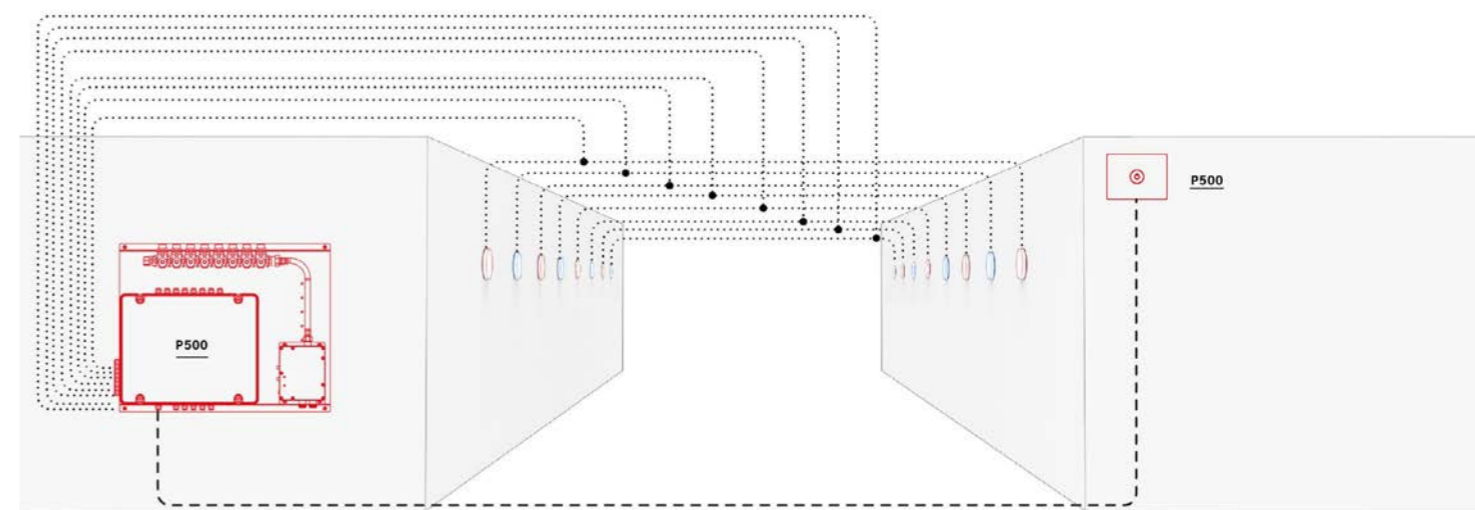
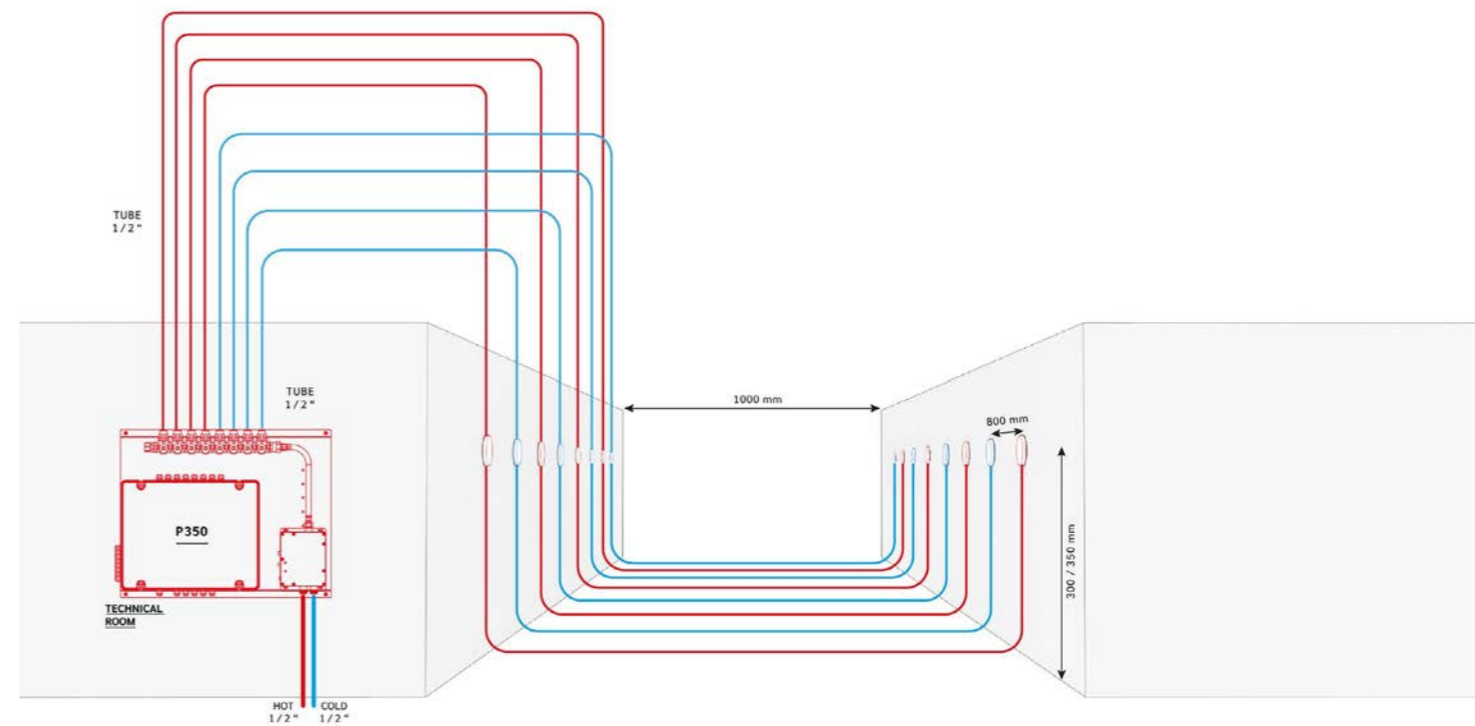

COMPONENTS / COMPONENTI

BODYJET
BL85C2 - BL85C6

CONTROL PANEL
P500

FEATURES / CARATTERISTICHE

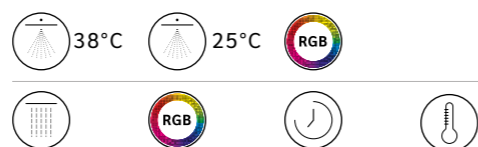

LEGEND / LEGENDA

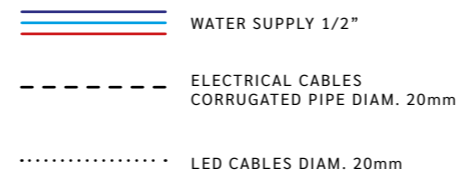

TECHINICAL INFORMATION / INFO TECNICHE

WATER FLOW	min 15 U/m
WATER SUPPLY	1/2" inch
OPERATING PRESSURE	1,5/5 bar
RECOMMENDED PRESSURE	3 bar

EMOTIONAL TUNNEL

/ TUNNEL EMOZIONALE

Emotional tunnel composed by 6 experience shower with different types of jets and chromotherapy complete with professional control unit for sequential activation via single button of the experience shower. Possibility to set different parameters by selecting: times, sequence of jets, RGB lights, water temperature via electronic mixer. Possibility to manage the optional aromatherapy and music.

Tunnel emozionale composto da 6 docce emozionali con diverse tipologie di getti e cromoterapia completo di centralina professionale per l'attivazione sequenziale tramite singolo pulsante del percorso sensoriale. Possibilità di impostare diversi parametri selezionando: tempi, sequenza dei getti, luci RGB, temperatura dell'acqua tramite miscelatore elettronico. Possibilità di gestire gli optional di aromaterapia e musica.

EMOTIONAL TUNNEL

AMBIENT: PUBLIC

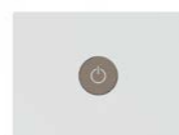

COMPONENTS / COMPONENTI

SHOWERHEADS
R35C1 - R35C2 - R35C3 - R35C4 - R35C5 - R35C6

CONTROL PANEL
P500

FEATURES / CARATTERISTICHE



APPLICATIONS

PREDISPOSITION

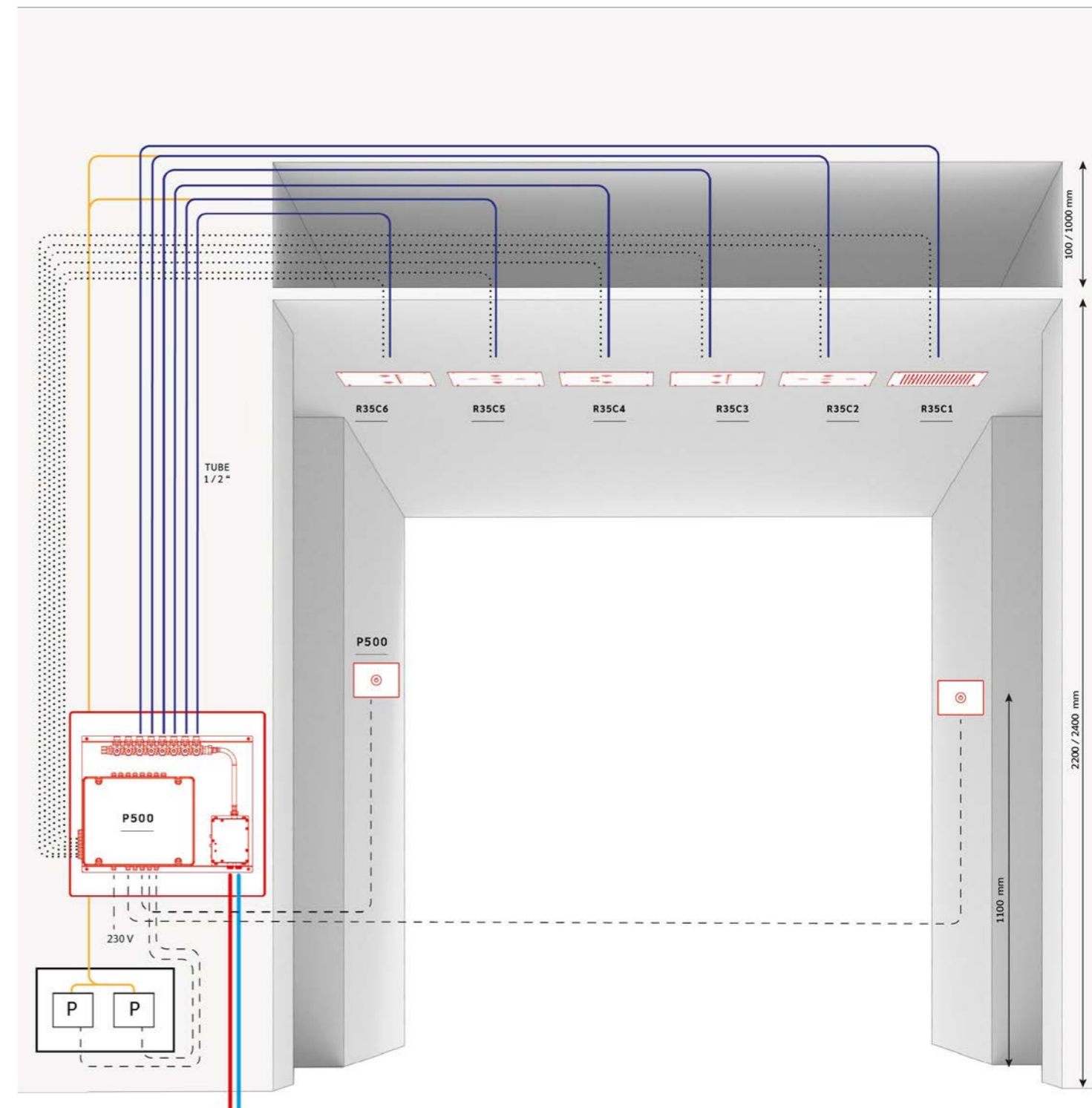

LEGEND / LEGENDA

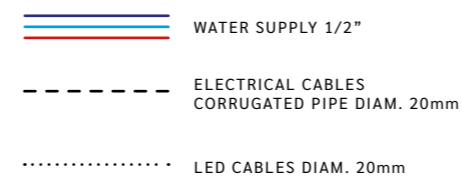

TECHINICAL INFORMATION / INFO TECNICHE

WATER FLOW	min 15 U/m
WATER SUPPLY	1/2" inch
OPERATING PRESSURE	1,5/5 bar
RECOMMENDED PRESSURE	3 bar

PRIVATE SPA

/ SPA PRIVATA

LIBERA system composed by 5 modules with different types of jets and customize case in different finishes completed by professional control unit for the activation of 4 different customizable scenarios. Possibility to set the parameters of water and RGB + W light in timed or on / off mode. Possibility to manage the optional aromatherapy and music. Flush-mounted stainless steel keyboard with 4 buttons for activation of different scenarios. Temperature management through manual thermostatic.

Sistema doccia LIBERA composto da 5 differenti moduli con diverse tipologie di getto, case personalizzabile con diverse finiture, completo di centralina di controllo professionale per l'attivazione di 4 differenti scenari personalizzabili. Possibilità di impostare i parametri di acqua e luce RGB+W in modalità temporizzata o on/off. Possibilità di gestire gli optional di aromaterapia e musica. Tastiera da incasso in acciaio inox filo muro con 4 pulsanti per l'attivazione dei diversi scenari. Gestione della temperatura tramite termostatico manuale.

PRIVATE SPA

AMBIENT: PUBLIC

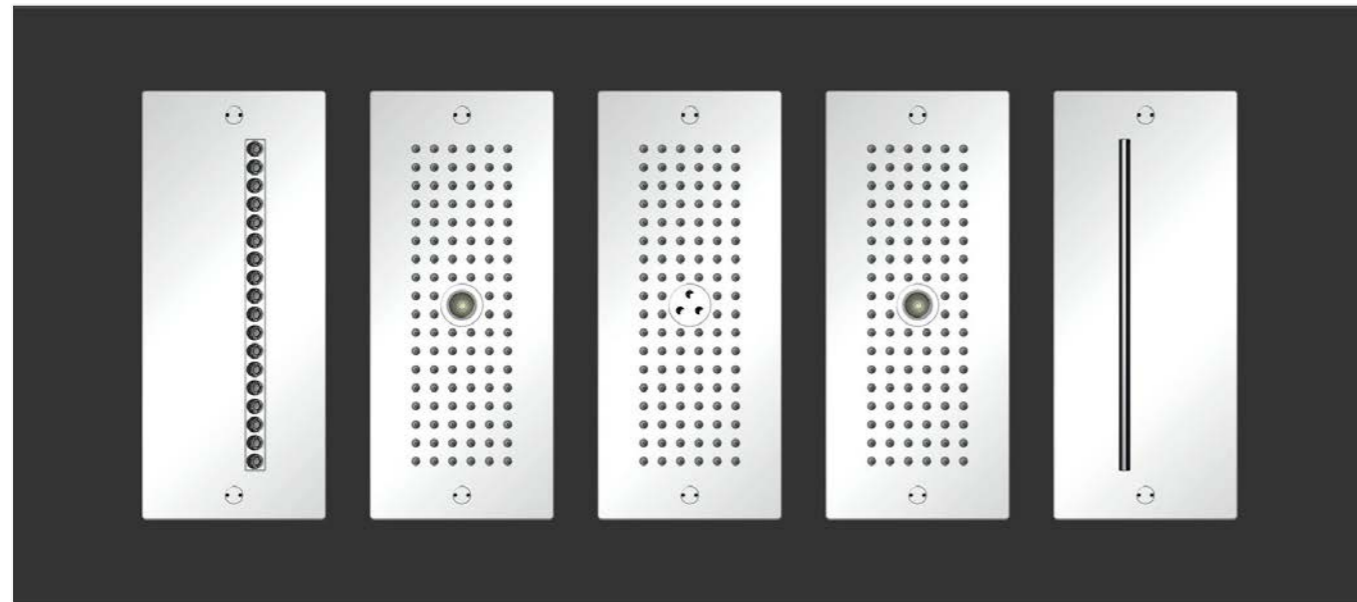

COMPONENTS / COMPONENTI

SHOWERHEADS LIBERA
N3515C3A - R3515C1 - N3515C12 - R3515C1 - N3515C4

CONTROL PANEL
C48 PRO + GTQ1

FEATURES / CARATTERISTICHE

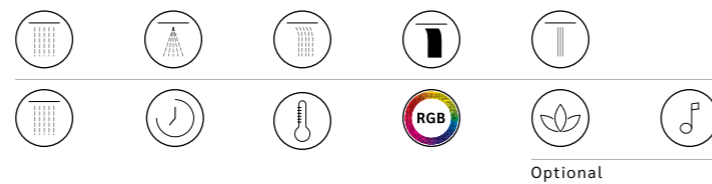

APPLICATIONS

PREDISPOSITION

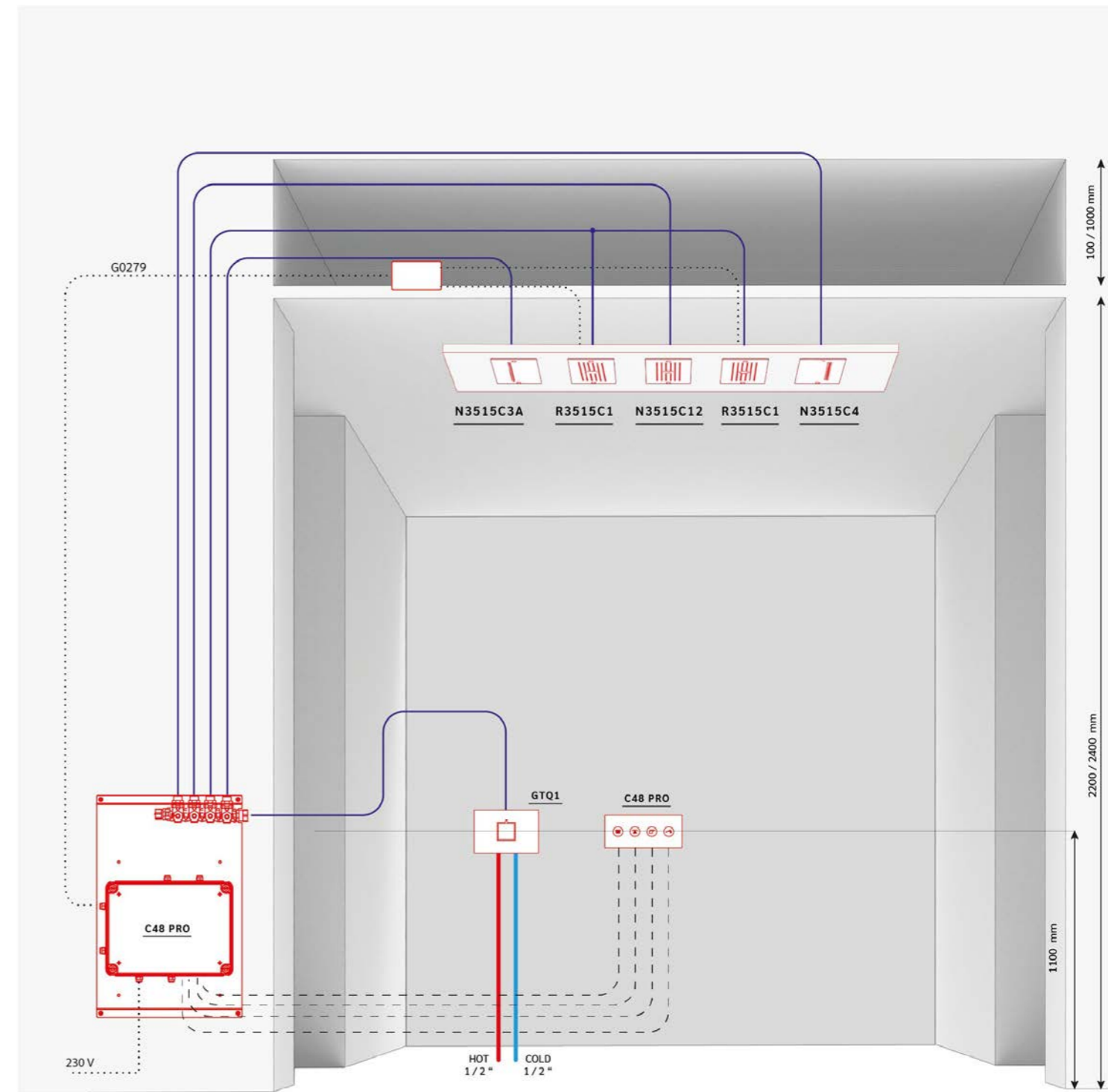

LEGEND / LEGENDA

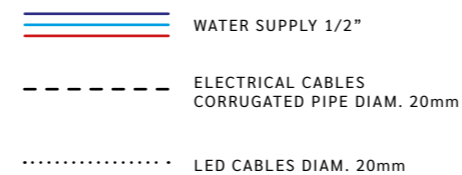

TECHINICAL INFORMATION / INFO TECNICHE

WATER FLOW	min 15 l/m
WATER SUPPLY	1/2" inch
OPERATING PRESSURE	1,5/5 bar
RECOMMENDED PRESSURE	3 bar

REACTION SHOWER

/ DOCCIA DI REAZIONE

Reaction shower composed by body jets with led RGB with rain jets and atomized jets completed by professional control unit for the activation of 4 different customizable scenarios. Possibility to set the parameters of water and RGB + W light in timed or on / off mode. Possibility to manage the optional aromatherapy and music. Flush-mounted stainless steel keyboard with 4 buttons for activation of different scenarios. Temperature management through manual thermostatic.

Doccia di reazione composta da body jet con led RGB con getti pioggia e atomizzati completo di centralina di controllo professionale per l'attivazione di 4 differenti scenari personalizzabili. Possibilità di impostare i parametri di acqua e luce RGB+W in modalità temporizzata o on/off. Possibilità di gestire gli optional di aromaterapia e musica. Tastiera da incasso in acciaio inox filo muro con 4 pulsanti per l'attivazione dei diversi scenari. Gestione della temperatura tramite termostatico manuale.

REACTION SHOWER

AMBIENT: PUBLIC



COMPONENTS / COMPONENTI

REACTION SHOWER
BL85C6 - BL85C1

CONTROL PANEL
C45 PRO + GTQ1

FEATURES / CARATTERISTICHE

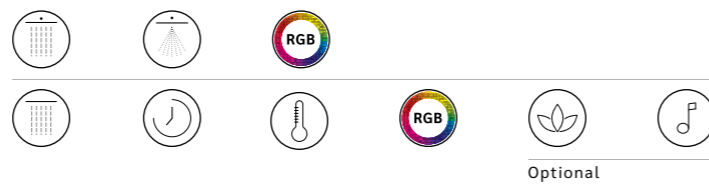

Optional

APPLICATIONS

PREDISPOSITION

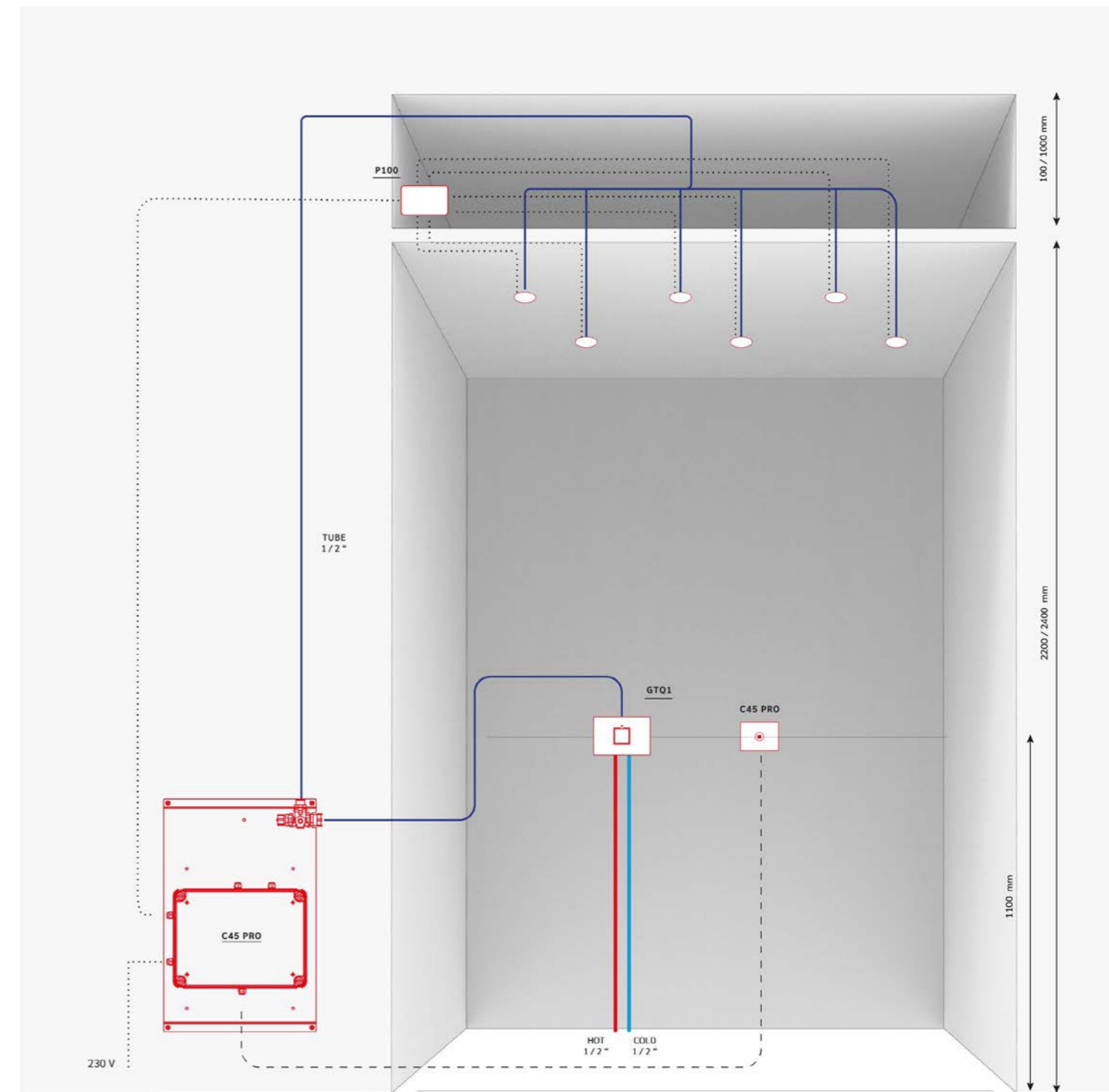

LEGEND / LEGENDA

- WATER SUPPLY 1/2"
- ELECTRICAL CABLES
CORRUGATED PIPE DIAM. 20mm
- LED CABLES DIAM. 20mm

TECHINICAL INFORMATION / INFO TECNICHE

WATER FLOW	min 15 U/m
WATER SUPPLY	1/2" inch
OPERATING PRESSURE	1,5/5 bar
RECOMMENDED PRESSURE	3 bar

PRIVATE SPA

/ SPA Private

Wellness can also be sought in your daily private domestic life: this is why aquaform products are easily adaptable to every home setting, in order to bring quality into your bathroom.

Il benessere può essere ricercato anche nella quotidianità privata di ogni casa: ecco perché i prodotti aquaform si adattano facilmente a ogni contesto casalingo, portando la qualità nel tuo bagno.



EMOTIONAL SHOWER

/ DOCCIA EMOZIONALE

Emotional shower with different types of jets and chromotherapy, completed 4.3" touch screen keyboard, with possibility to control and customize all the functions of the experience shower with a single interface. Possibility to manage up to 6 output ways by solenoid valves. Activation of the jets, management of the flow rate and water temperature via electronic mixer. Managing chromotherapy and dry aromatherapy, integrated radio and Bluetooth.

Doccia emozionale con diverse tipologie di getto e cromoterapia, completa di Tastiera touch screen da 4,3", con la possibilità di controllare e personalizzare tutte le funzioni della doccia emozionale tramite un'unica interfaccia. Possibilità di gestire fino a 6 uscite tramite elettrovalvole. Attivazione dei getti, gestione della portata e temperatura dell'acqua tramite miscelatore elettronico. Gestione cromoterapia e aromaterapia a secco, con radio e Bluetooth integrati.

EMOTIONAL SHOWER

AMBIENT: PRIVATE

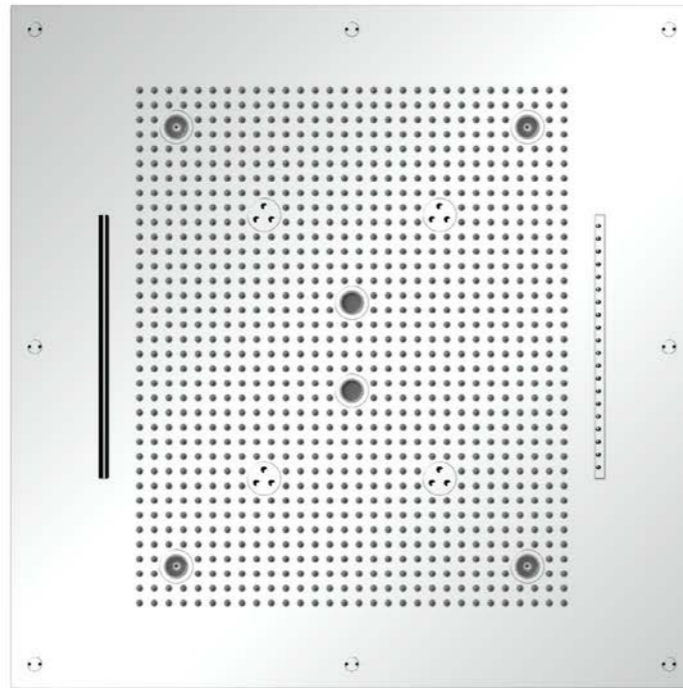

COMPONENTS / COMPONENTI

SHOWERHEAD
R70C12L3A4

CONTROL PANEL
C60 + V100

FEATURES / CARATTERISTICHE

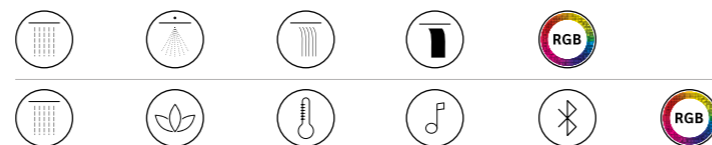

APPLICATIONS

PREDISPOSITION

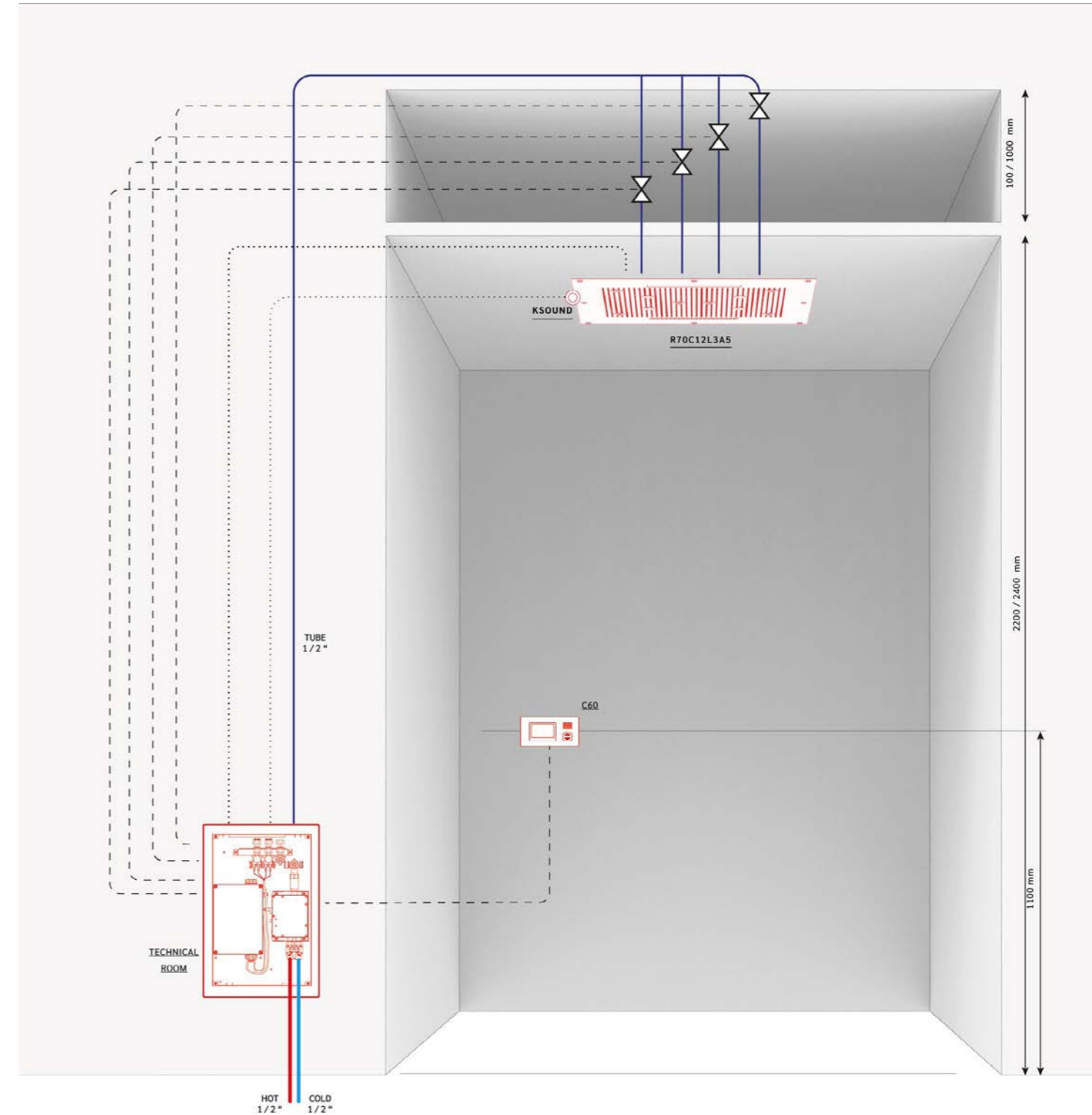

LEGEND / LEGENDA

- WATER SUPPLY 1/2"
- ELECTRICAL CABLES
CORRUGATED PIPE DIAM. 20mm
- LED CABLES DIAM. 20mm

TECHINICAL INFORMATION / INFO TECNICHE

WATER FLOW	min 15 U/m
WATER SUPPLY	1/2" inch
OPERATING PRESSURE	1,5/5 bar
RECOMMENDED PRESSURE	3 bar

SUITE SPA

/ SPA SUITE

LIBERA system composed by 2 modules and square showerhead with different types of jets and customize case in different finishes completed with 3.5" touch screen keyboard with the possibility to control and customize and functions of the experience shower. Possibility to manage up to 4 output ways through solenoid valves. Activation of the jets. Chromotherapy. Optional aromatherapy via separate diffuser. Temperature management through manual thermostatic.

Sistema doccia LIBERA composto da 2 moduli e un soffione quadro al centro con diverse tipologie di getto e case personalizzabile con diverse finiture completo di Tastiera touch screen da 3,5" con la possibilità di controllare e personalizzare e funzioni della doccia emozionale. Possibilità di gestire fino a 4 vie d'uscita tramite elettrovalvole. Attivazione dei getti. Cromoterapia. Aromaterapia opzionale tramite diffusore separato. Gestione della temperatura tramite termostatico manuale.

SUITE SPA LIBERA

AMBIENT: PRIVATE

PREDISPOSITION

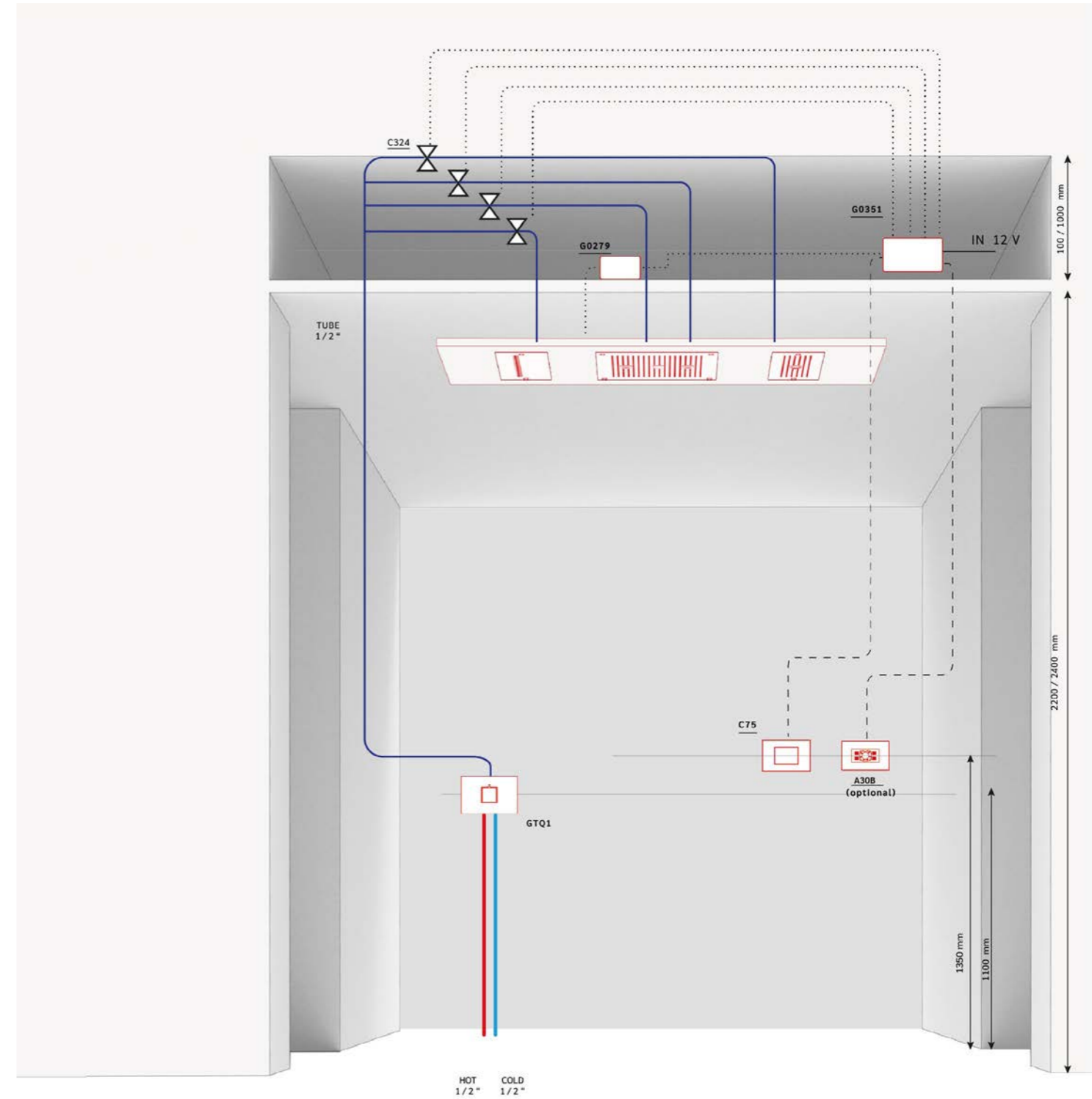
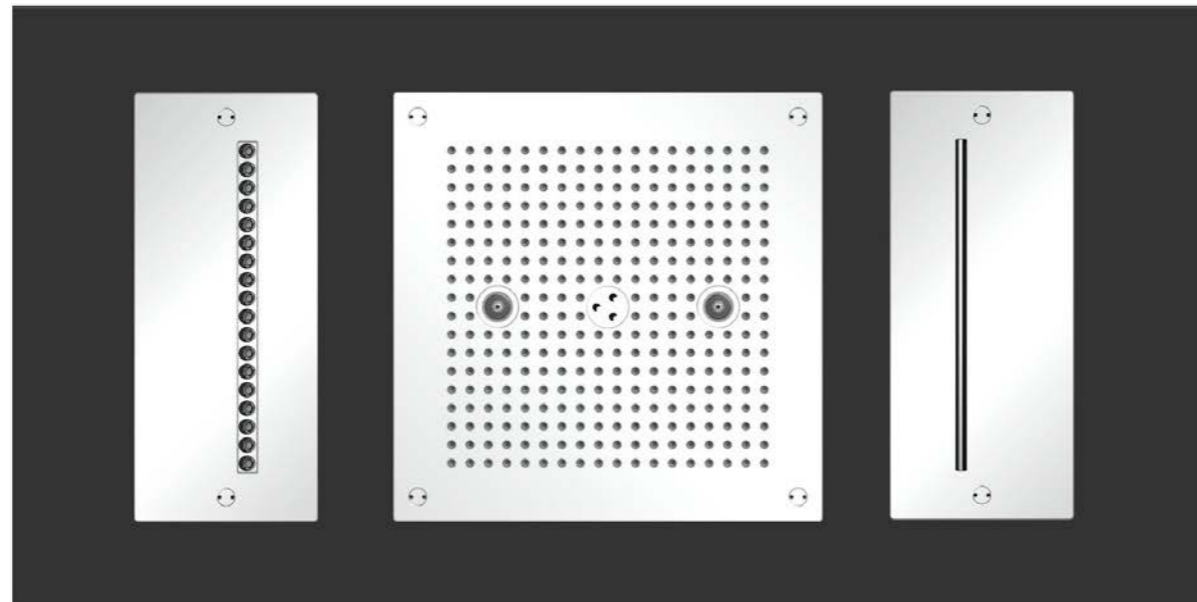

COMPONENTS / COMPONENTI

SHOWERHEAD
N3515C3A - R35C12 - N3515C4

CONTROL PANEL
C75 + A30 + GTQ1

FEATURES / CARATTERISTICHE

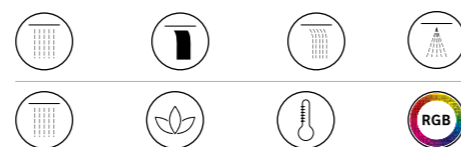

APPLICATIONS

LEGEND / LEGENDA

- WATER SUPPLY 1/2"
- ELECTRICAL CABLES
CORRUGATED PIPE DIAM. 20mm
- LED CABLES DIAM. 20mm

TECHINICAL INFORMATION / INFO TECNICHE

WATER FLOW	min 30 l/m
WATER SUPPLY	1/2" inch
OPERATING PRESSURE	1,5/5 bar
RECOMMENDED PRESSURE	3 bar

PRIVATE LUMINA

/ PRIVATE LUMINA

Showerhead with different types of jets and spotlight with white lights, completed with paired push-button panels, in stainless steel, for on / off management of water jets and independent control of chromotherapy and aromatherapy. Manual thermostatic for temperature management.

Soffione doccia con differenti tipologie di getto e faretti led con luce bianca, completo di pulsantiere in coppia, in acciaio inox filo muro, per la gestione on/off dei getti d'acqua e controllo luce bianca. Termostatico manuale per la gestione della temperatura.

PRIVATE LUMINA

AMBIENT: PRIVATE

PREDISPOSITION

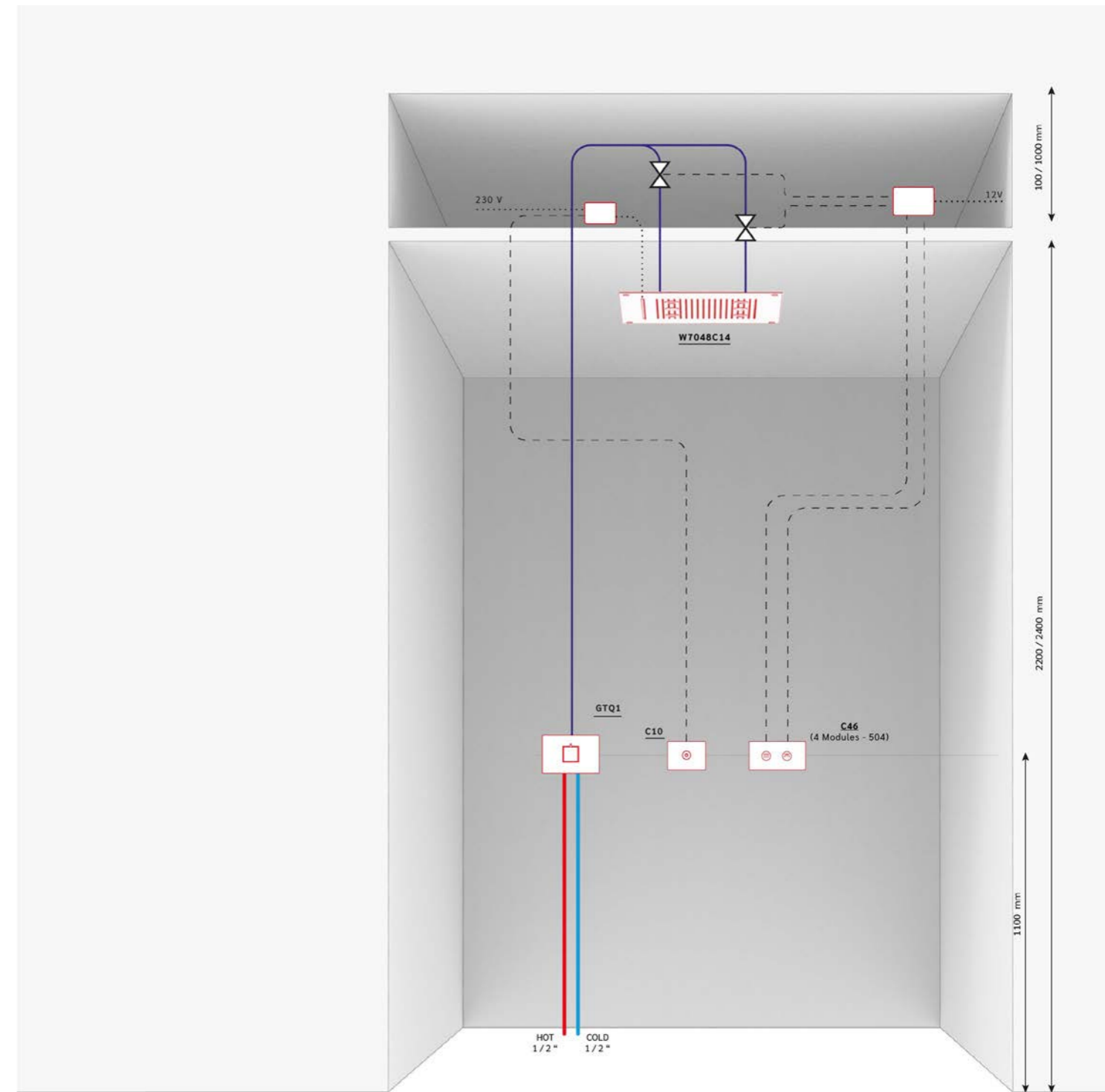
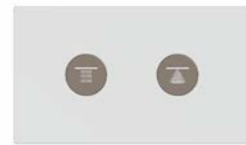
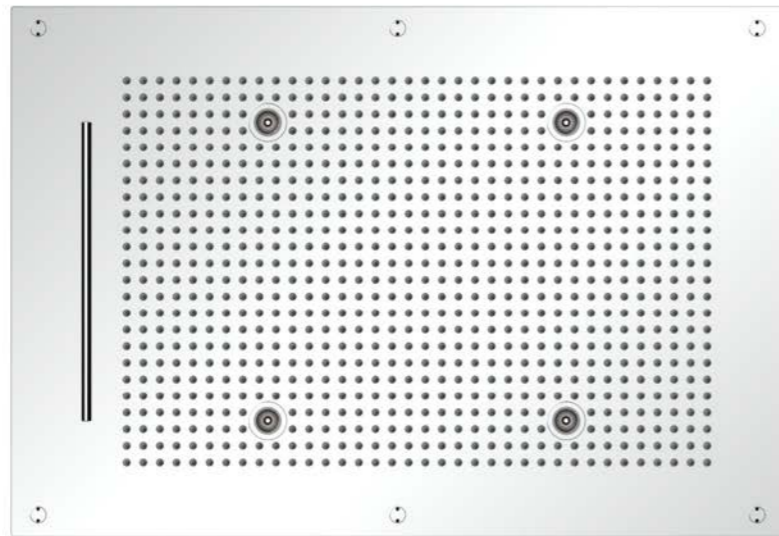

COMPONENTS / COMPONENTI

SHOWERHEAD
LUMINA W7048C14

CONTROL PANEL
C46 + C10 + GTQ1

FEATURES / CARATTERISTICHE

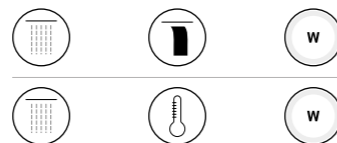

LEGEND / LEGENDA

- WATER SUPPLY 1/2"
- ELECTRICAL CABLES
CORRUGATED PIPE DIAM. 20mm
- LED CABLES DIAM. 20mm

TECHINICAL INFORMATION / INFO TECNICHE

WATER FLOW	min 30 U/m
WATER SUPPLY	1/2" inch
OPERATING PRESSURE	1,5/5 bar
RECOMMENDED PRESSURE	3 bar

ESSENTIA SPA

/ SPA ESSENTIA

Showehead with different types of jets completed with thermostatic diverter for water flow rate and temperature setting.

Soffione doccia con differenti tipologie di getto completo di deviatore termostatico per la gestione dell'acqua e della sua temperatura.

ESSENTIA SPA

AMBIENT: PRIVATE

PREDISPOSITION

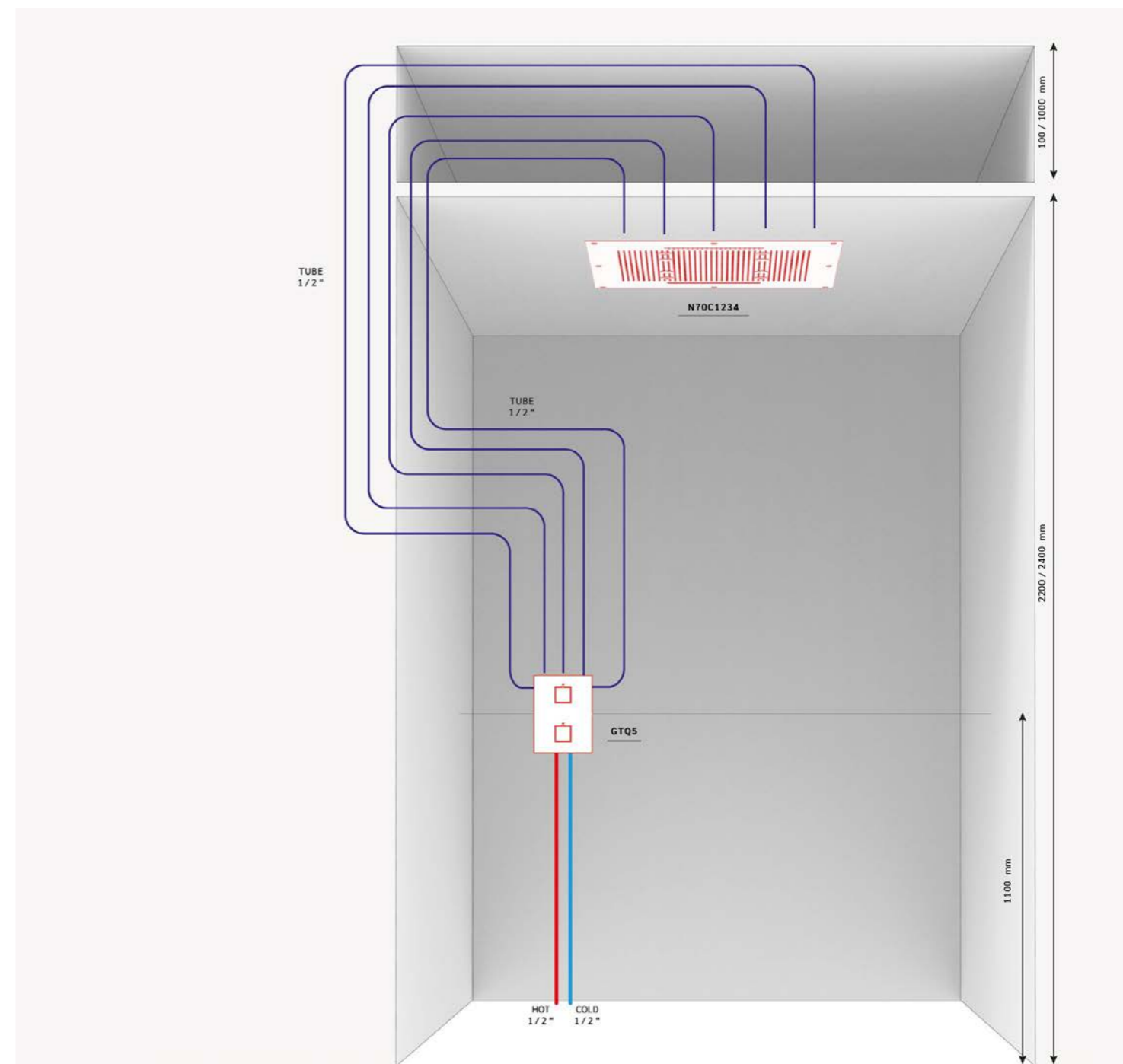
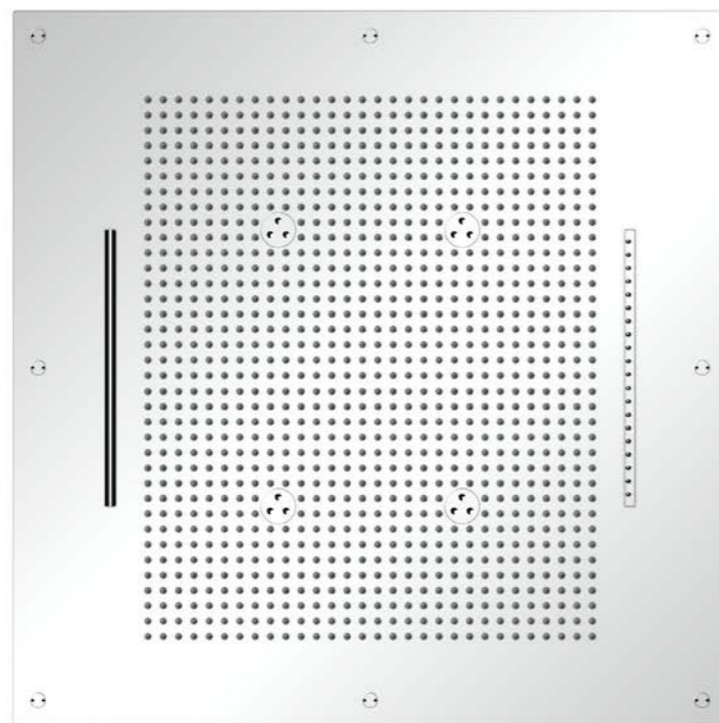

COMPONENTS / COMPONENTI

SHOWERHEAD
ESSENTIA N70C1234

CONTROL PANEL
GTQ5C

FEATURES / CARATTERISTICHE

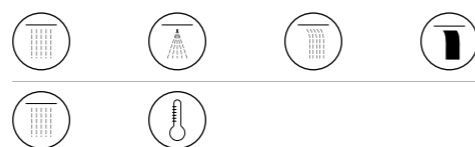

APPLICATIONS

LEGEND / LEGENDA

- WATER SUPPLY 1/2"
- ELECTRICAL CABLES
CORRUGATED PIPE DIAM. 20mm
- LED CABLES DIAM. 20mm

TECHINICAL INFORMATION / INFO TECNICHE

WATER FLOW	min 30 l/m
WATER SUPPLY	1/2" inch
OPERATING PRESSURE	1,5/5 bar
RECOMMENDED PRESSURE	3 bar

TAILOR MADE

/ SPA personalizzate

aquaform provides customized solutions, putting its knowledge and skills at your service in order to create unique and tailor made products. From the finishes to the sizes, up to the multiple functions, aquaform will listen to any demand and will shape a product fit to every need. In cooperation with bbspa&partners, aquaform can develop new configurations and water managing programs for SPAs path designed to satisfy your needs.

aquaform fornisce soluzioni personalizzate, mettendo a vostra disposizione le proprie conoscenze e capacità per realizzare prodotti unici su misura. Dalle finiture alle misure, fino alle diverse funzioni, aquaform saprà ascoltare ogni richiesta e dare forma a un prodotto adatto a ogni esigenza. In collaborazione con bbspa&partners potrà sviluppare per voi nuove configurazioni e nuovi programmi di gestione dell'acqua per percorsi spa totalmente calibrati sulle vostre esigenze.

TAILOR MADE

/ Soffioni SPA personalizzati

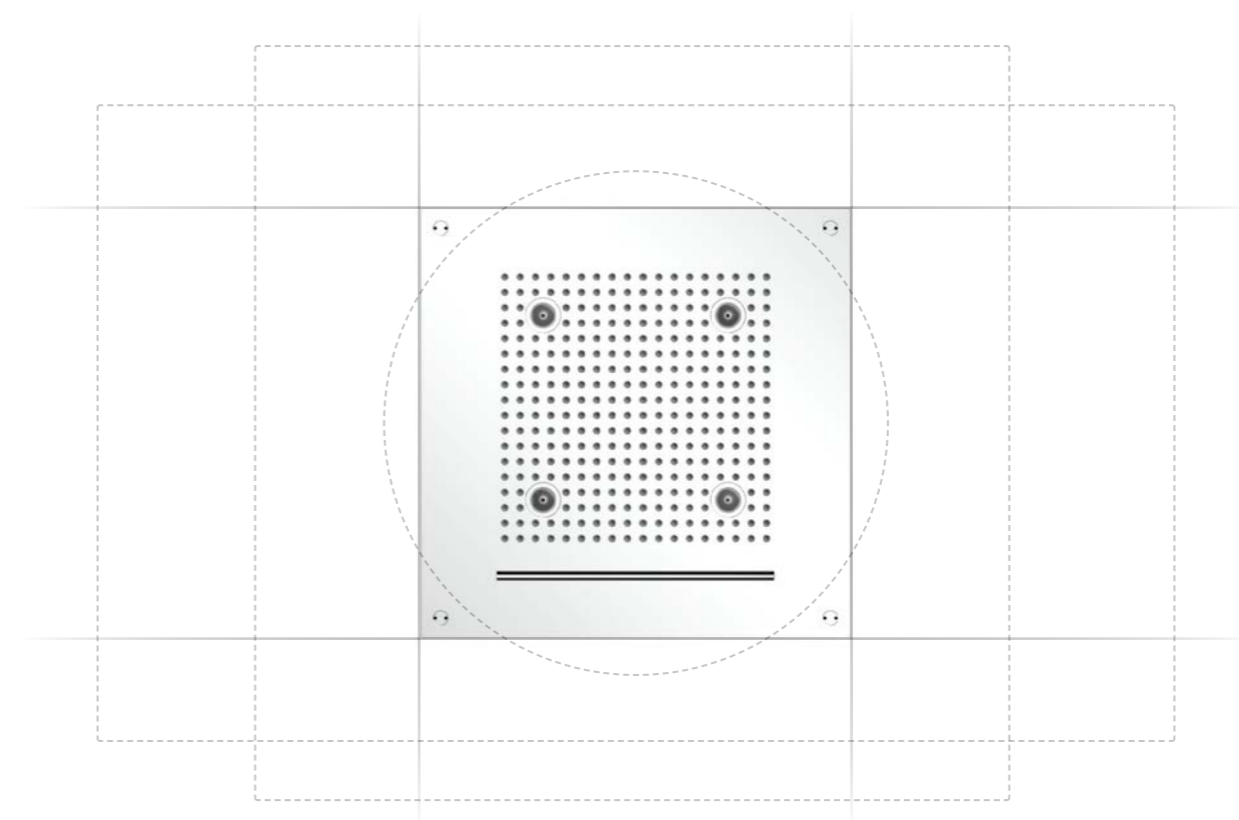

Dimensions / *Dimensione*



Functions / *Funzioni*



Finishes / *Finiture*



Compositions / *Composizioni*



Sound / *Suono*

R10060C1345

1000 X 600

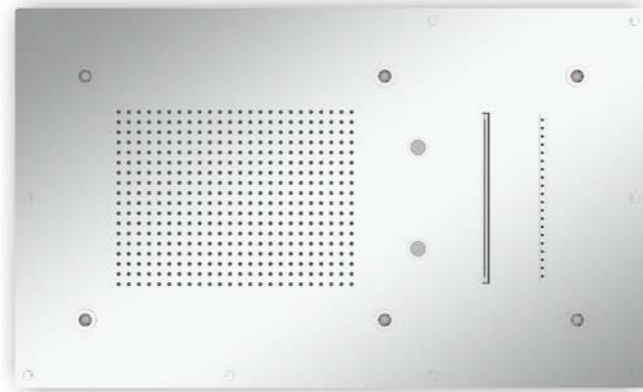

R12080C125

1200X800

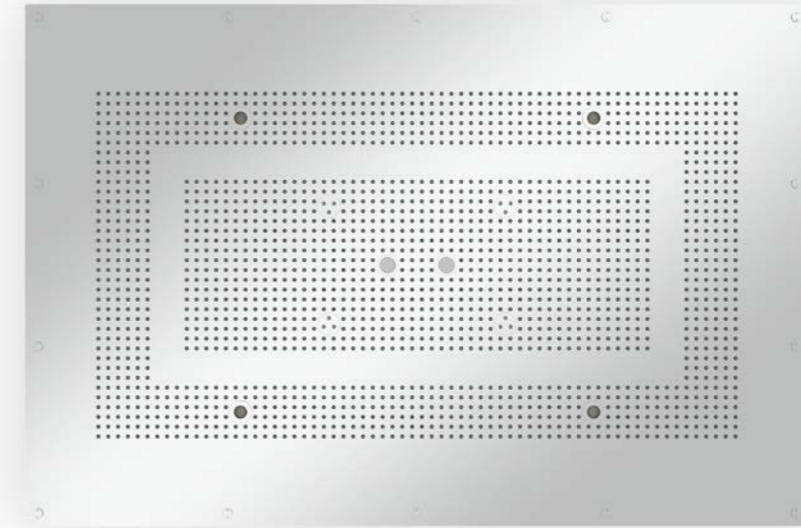

R100C1234

1000 X 1000

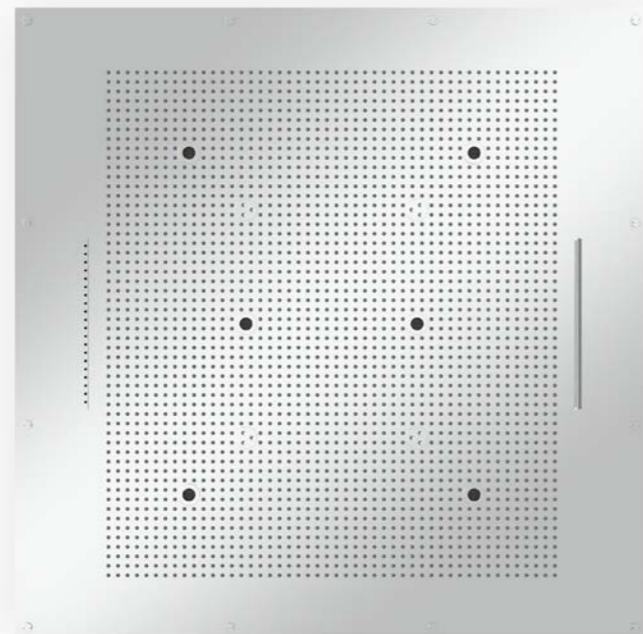

W23070C1

2300X700

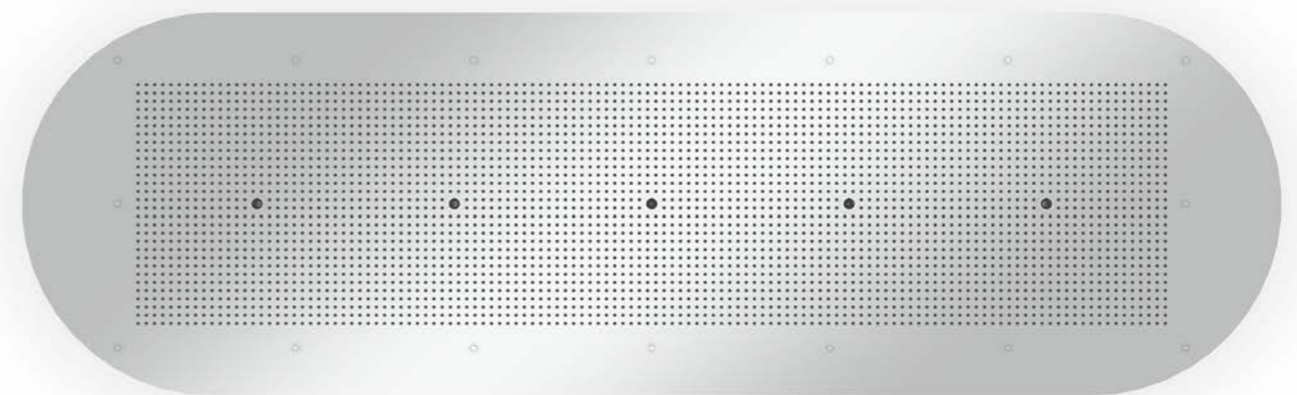



COLLECTIONS

/ Collezioni

SHOWERHEADS WITH CHROMOTHERAPY

SENSUS

92

HORIZONTAL SHOWER

AQUAMOTUS - AF FUSION - NADIR - ZENIT

104

MODULAR SHOWERHEADS

LIBERA

124

SHOWERHEADS WITH WHITE LIGHT

LUMINA

140

SHOWERHEADS

ESSENTIA

154

CONTROLS

166

BODYJET

174

SHOWERHEADS WITH CHROMOTHERAPY

/ SOFFIONI CON CROMOTERAPIA

SENSUS

AN EMOTIONAL JOURNEY THROUGH SENSATIONS.
UN VIAGGIO EMOZIONALE ATTRAVERSO I SENSI.

Born from the magical combination of aquatherapy and chromotherapy, the Sensus collection invites you on a journey through senses and emotions, creating moments of incomparable well-being. The skin contact with water, associated with the chromotherapeutic atmospheres of light and colour, brings benefit to our inner life as well as to our physical wellness.

Nata dalla magica unione tra acquaterapia e cromoterapia, la serie Sensus promette un viaggio attraverso i sensi e le emozioni, volto a creare momenti di ineguagliabile benessere. Il contatto della nostra pelle con l'acqua, associato alle atmosfere di luci e colori della cromoterapia, porta beneficio alla nostra interiorità così come al nostro benessere fisico.

FEATURES**Minimal flow rate**

The showerheads are designed to work perfectly even with low-pressure systems.

16 colours

The latest generation RGB LED lights guarantee a wide range of colours, suitable for every mood.

100mm minimal recess

The minimal height of the recessed body makes installation more practical and allows a greater aesthetic elegance.

Stand alone SPA

The Sensus collection contains the entire experiences range for a complete emotional journey in a single product.

Sound

Our products can be equipped with Bluetooth and radio connections for listening to music and sounds.

CARATTERISTICHE**Portata minima**

I prodotti sono pensati per funzionare perfettamente anche con impianti a bassa pressione.

16 colori

Luci LED RGB di ultima generazione garantiscono un'ampia gamma di colori, adatta a ogni stato d'animo.

100mm incasso minimo

L'altezza minima del corpo incasso rende l'installazione più pratica e garantisce una maggiore eleganza estetica.

SPA in uno

La collezione Sensus racchiude in un unico prodotto l'intera gamma di esperienze di un completo percorso emozionale.

Musica

I nostri prodotti possono essere dotati di connessioni Bluetooth e radio per l'ascolto di musica e suoni.



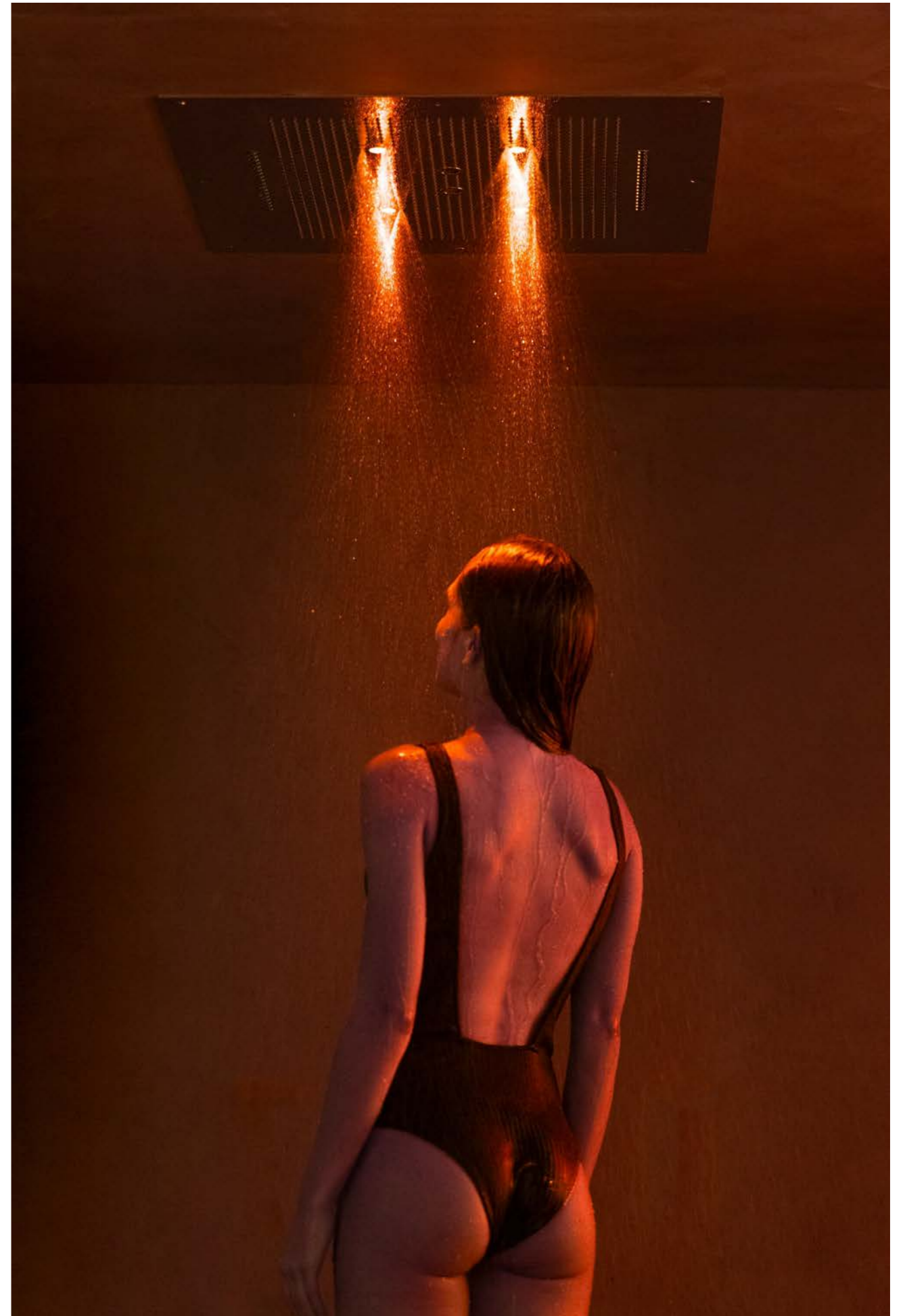
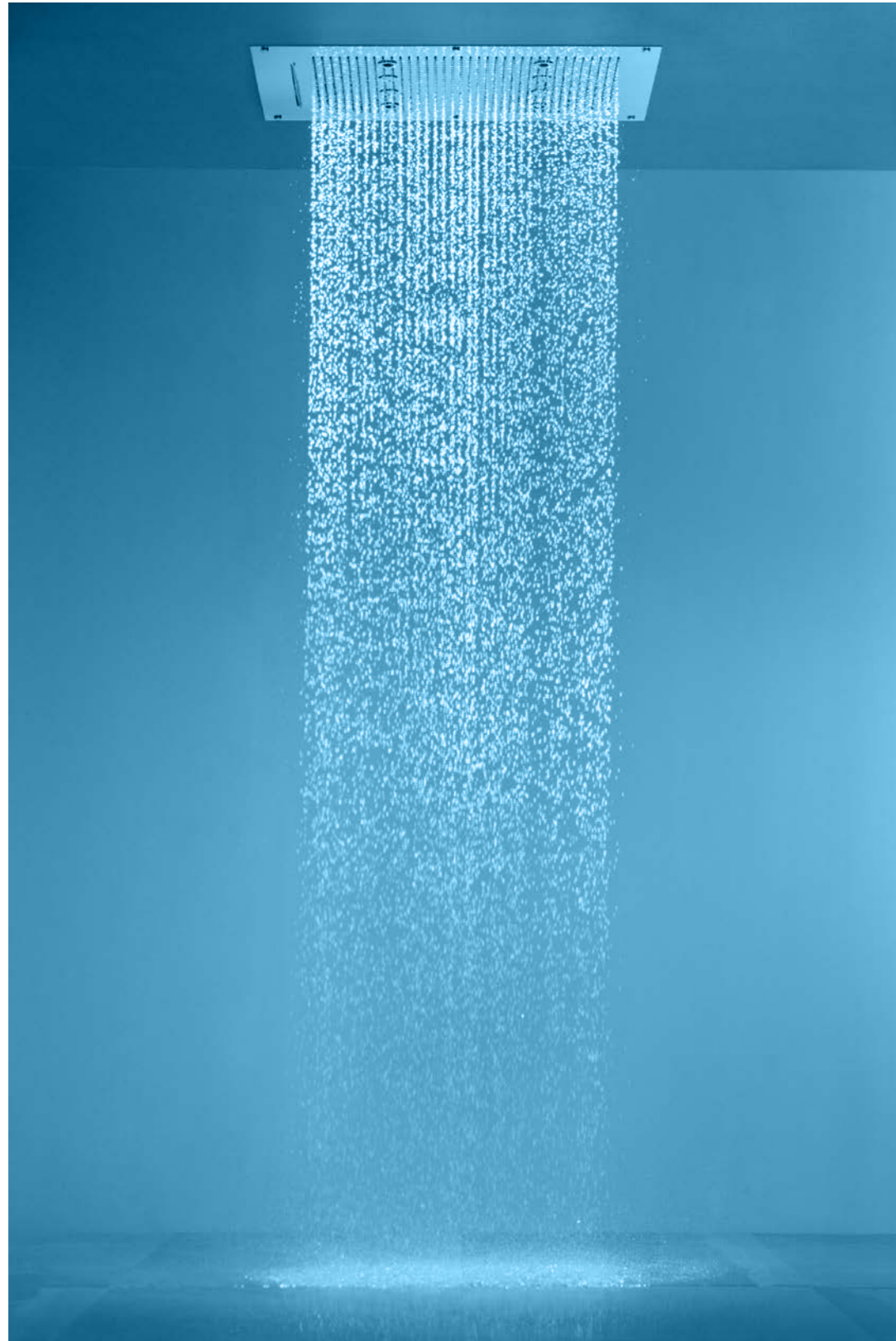

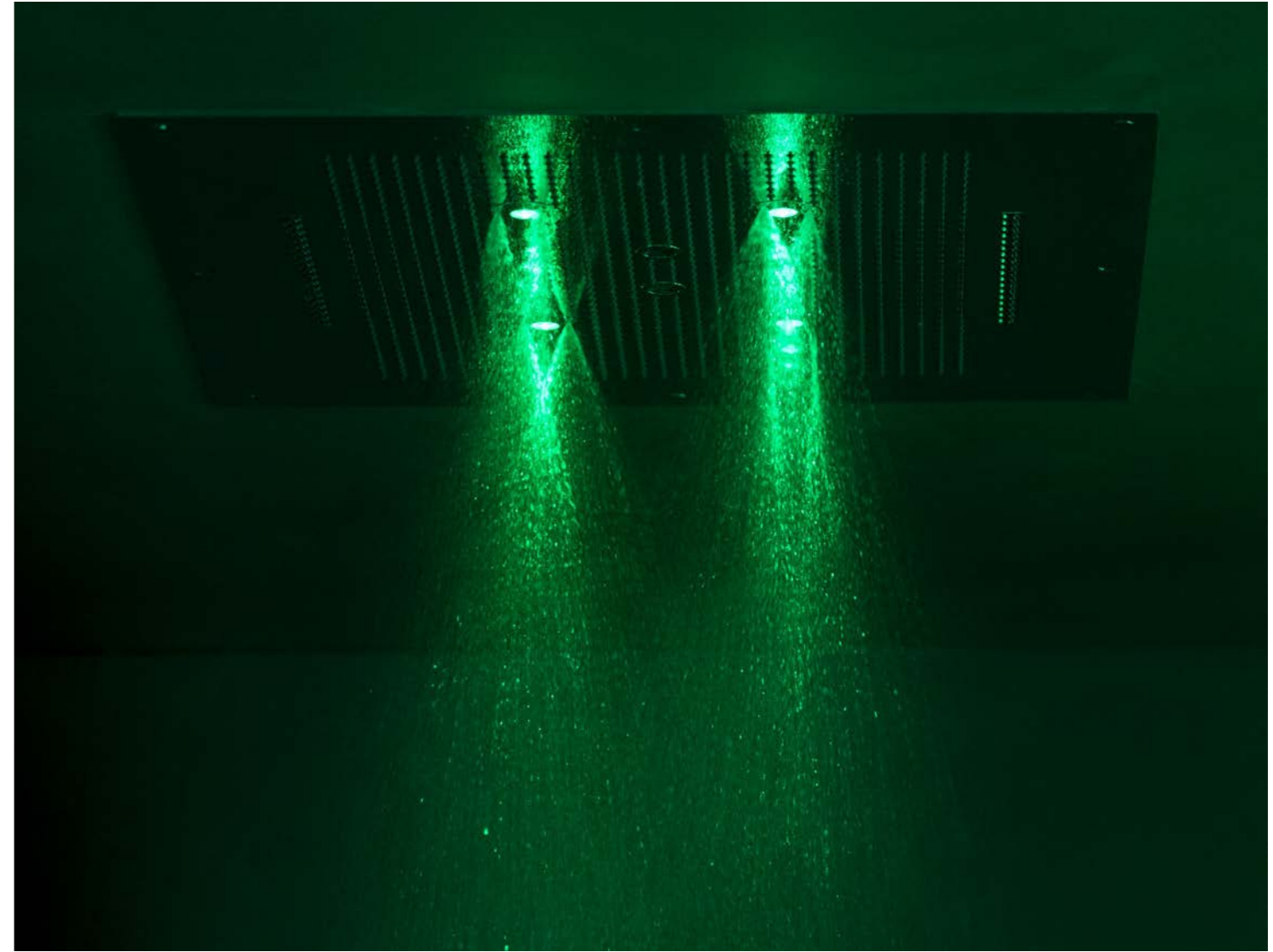

SENSUS / R70C12L3A5

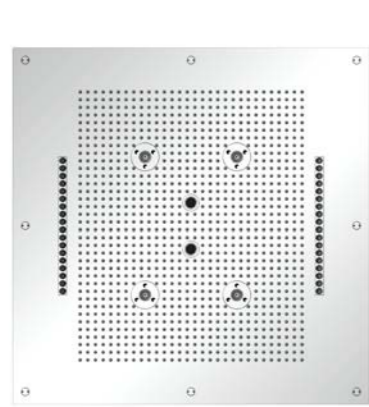

Body: 700x700 mm square recessed shower head.
Function: rain jet, 2 aerated, 4 nebulized LED, 2 tropical aerated and 4 LED spotlights with chromotherapy.
Wet surface: 435x525mm.
Recessed: 100 mm.
 Complete with fixing system.

Corpo: Soffione quadro da incasso 700x700 mm.
Funzione: Getto pioggia, 2 aerati, 4 nebulizzati LED, 2 tropicali aerati e 4 faretti LED con cromoterapia.
Superficie bagnata: 435x525mm.
Incasso: 100 mm.
 Completo di sistema di fissaggio.



Collaboration with
bbspa
BY A SPINNING TOP

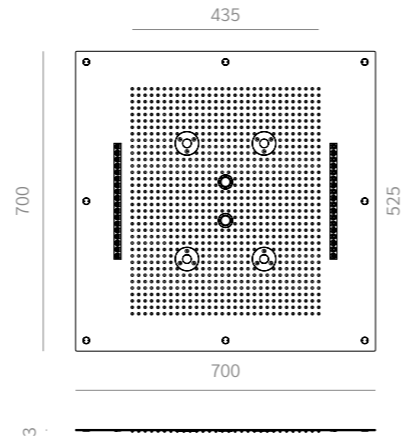

SENSUS / R7048C12

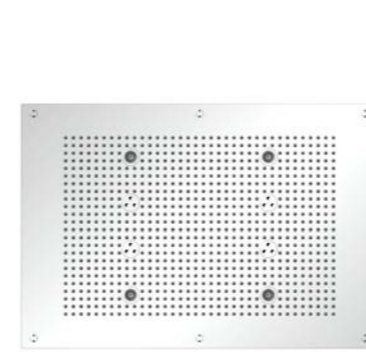

Body: 700x480 mm rectangular recessed shower head.
Function: Rain jet, 2 nebulized 4 LED spotlights with chromotherapy.
Wet surface: 525x345mm.
Recessed: 100 mm.
 Complete with fixing system.

Corpo: Soffione rettangolare da incasso 700x480 mm.
Funzione: Getto pioggia, 2 nebulizzati inclusi 4 faretti LED con cromoterapia.
Superficie bagnata: 525x345mm.
Incasso: 100 mm.
 Completo di sistema di fissaggio.

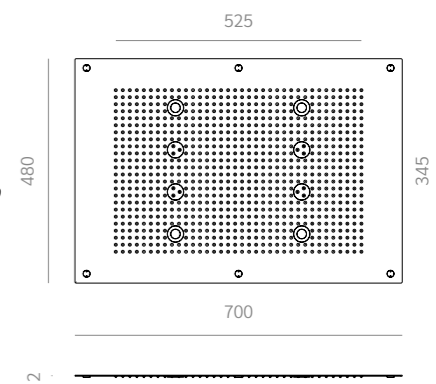

SENSUS / R70C1234

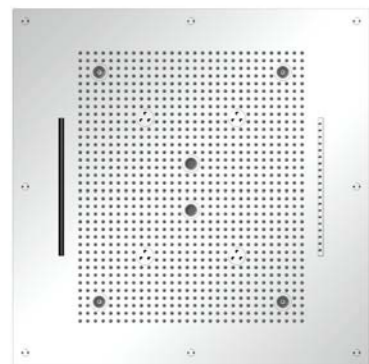

Body: 700x700 mm square recessed shower head.
Function: Rain jet, waterfall, 4 nebulized, 1 tropical and 6 LED spotlights with chromotherapy.
Wet surface: 435x525mm.
Recessed: 100 mm.
 Complete with fixing system.

Corpo: Soffione quadro da incasso 700x700 mm.
Funzione: Getto pioggia, cascata, 4 nebulizzati, 1 tropicale e 6 faretti LED con cromoterapia.
Superficie bagnata: 435x525mm.
Incasso: 100 mm.
 Completo di sistema di fissaggio.

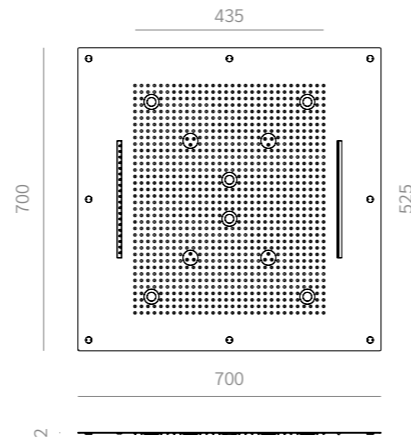

SENSUS / RT65C125



Body: Ceiling mounted recessed round showerhead Ø650 mm.
3 water-pattern: 1 rain jet, 3 nebulized jets, 1 aerated jet included 5 spotlights led with chromotherapy.
Water Supply: 1/2" inch
Operating pressure: 1,5 /5 bar
Recommended pressure: 3 bar
 Complete with fixing system
N.B. To be teamed with systems to manage hydraulic and electric part

Corpo: Soffione tondo da incasso Ø 650 mm
3 funzioni: 1 getto pioggia, 3 getti nebulizzati, 1 getto aerato inclusi 5 faretti led con cromoterapia.
Profondità incasso: 100 mm
Alimentazione: 1/2" pollice
Pressione di esercizio: 1,5 /5 bar
Pressione consigliata: 3 bar
 Completo di sistema di fissaggio.
N.B. da abbinare a sistemi per gestione idraulica ed elettrica

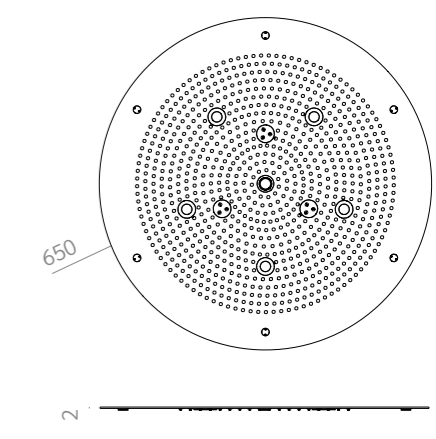

SENSUS / R70C1

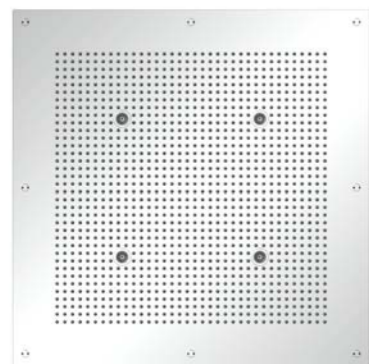

Body: 700x700 mm square recessed shower head.
Function: Rain jet and 4 LED spotlights with chromotherapy.
Wet surface: 525x525mm.
Recessed: 100 mm.
 Complete with fixing system.

Corpo: Soffione quadro da incasso 700x700 mm.
Funzione: Getto pioggia e 4 faretti LED con cromoterapia.
Superficie bagnata: 525x525mm.
Incasso: 100 mm.
 Completo di sistema di fissaggio.

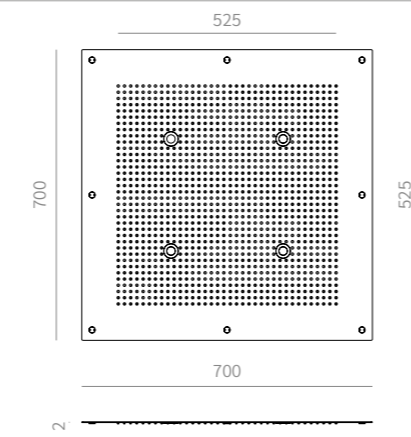

SENSUS / R5638C14

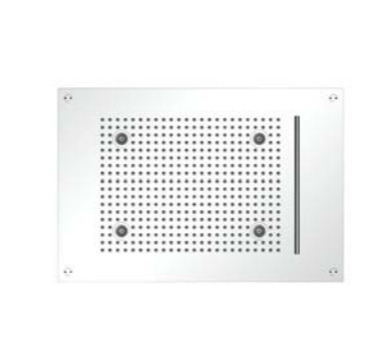

Body: 560x380 mm rectangular recessed shower head.
Function: Rain jet, waterfall and 4 LED spotlights with chromotherapy.
Wet surface: 345x255mm.
Recessed: 100 mm.
 Complete with fixing system.

Corpo: Soffione rettangolare da incasso 560x380 mm.
Funzione: Getto pioggia, cascata e 4 faretti LED con cromoterapia.
Superficie bagnata: 345x255mm.
Incasso: 100 mm.
 Completo di sistema di fissaggio.

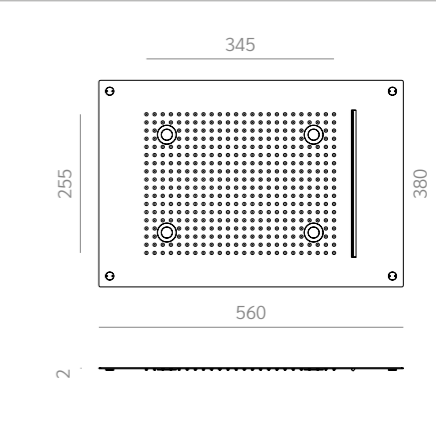

SENSUS / R50C12

NEW



Body: Ø 500 mm round recessed shower head.
Function: Rain jet, 3 nebulized and 3 LED spotlights with chromotherapy.
Wet surface: Ø 380 mm.
Recessed: 100 mm.
 Complete with fixing system.

Corpo: Soffione tondo da incasso Ø 500 mm.
Funzione: Getto pioggia, 3 nebulizzati e 3 faretti LED con cromoterapia.
Superficie bagnata: Ø 380 mm.
Incasso: 100 mm.
 Completo di sistema di fissaggio.

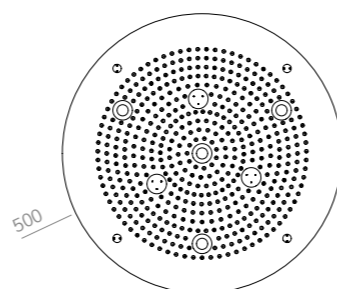

SENSUS / R42C14

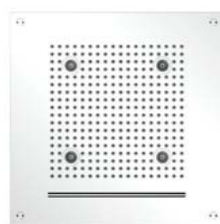

Body: Square recessed shower head 420x420 mm.
Function: Rain jet, waterfall and 4 LED spotlights with chromotherapy.
Wet surface: 255x255mm.
Recessed: 100 mm.
 Complete with fixing system.

Corpo: Soffione quadro da incasso 420x420 mm.
Funzione: Getto pioggia, cascata e 4 faretti LED con cromoterapia.
Superficie bagnata: 255x255mm.
Incasso: 100 mm.
 Completo di sistema di fissaggio.

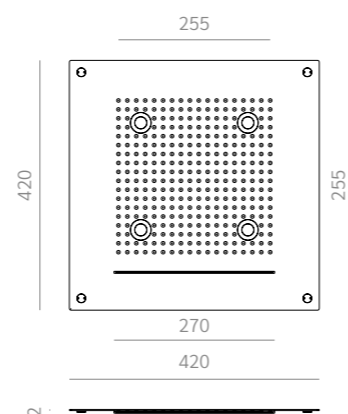

SENSUS / R35C1

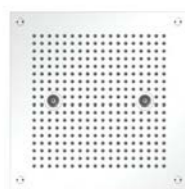

Body: 350x350 mm square recessed shower head.
Function: Rain jet and 2 LED spotlights with chromotherapy.
Wet surface: 255x255mm.
Recessed: 100 mm.
 Complete with fixing system.

Corpo: Soffione quadro da incasso 350x350 mm.
Funzione: Getto pioggia e 2 faretti LED con cromoterapia.
Superficie bagnata: 255x255mm.
Incasso: 100 mm.
 Completo di sistema di fissaggio.

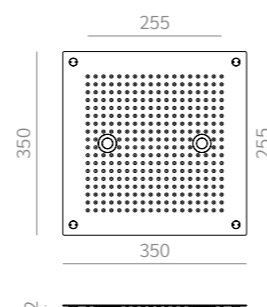

SENSUS / RP6015C1

NEW



Body: wall mounted shower head rain.
Function: 1 jet rain including 2 led spotlights RGB.
Feeding: 1/2 " inch
Working pressure: 1.5 / 5 bar
Recommended pressure: 3 bar
 Complete with system of fixing.

Corpo: Soffione doccia da parete effetto pioggia.
Funzione: 1 getto pioggia inclusi 2 faretti led RGB.
Alimentazione: 1/2" pollice
Pressione di esercizio: 1,5 / 5 bar
Pressione consigliata: 3 bar
 Completo di sistema di fissaggio.

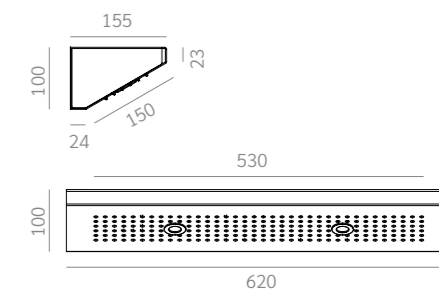

HORIZONTAL SHOWER

/ DOCCE ORIZZONTALI

AQUAMOTUS
AF FUSION
NADIR
ZENIT

**A COMPLETE MESSAGE WITHIN THE WALLS OF YOUR HOME.
UN MASSAGGIO COMPLETO TRA LE MURA DI CASA.**

Horizontal Shower is a new generation collection that allows experiencing for the first time the combined effects of a complete message and a balancing, relaxing or stimulating emotional journey. Perfectly adaptable to any environment, Horizontal Shower is available in its wall-mounted (ZENIT) or ceiling-mounted (AQUAMOTUS, AF FUSION, NADIR) version.

Horizontal Shower è una collezione di nuova generazione, che consente di sperimentare per la prima volta gli effetti congiunti di un massaggio completo e di un percorso emozionale di tipo equilibrante, rilassante o stimolante. Perfettamente adattabile a ogni ambiente, Horizontal Shower è disponibile nella sua variante a parete (ZENIT) o a soffitto (AQUAMOTUS, AF FUSION, NADIR).



FEATURES**Full massage**

The horizontal position of the shower guarantees the same effects and benefits of a full massage.

**16 programs (AQUAMOTUS)
4 programs (NADIR, ZENIT, AF FUSION)**

Four to sixteen massage programs, which combine rain jet, nebulization and RGB LED light.

Stand alone SPA

The horizontal shower reproduces in one product the experience of a real SPA.

Manual and programmable controls

The showers are equipped with a manual touch control, managing programs and individual jets.

Recessed handshower

To complete the domestic SPA experience, Zenit is also equipped with a recessed hand shower.

CARATTERISTICHE**Massaggio completo**

La posizione orizzontale della doccia garantisce gli stessi effetti e benefici di un massaggio completo.

**16 programmi (AQUAMOTUS)
4 programmi (NADIR, ZENIT, AF FUSION)**

Da quattro a sedici programmi massaggio, che combinano getto a pioggia, nebulizzazione e luce LED RGB.

SPA tutto in uno

La doccia orizzontale riproduce in un unico elemento l'esperienza di una vera e propria SPA.

Controlli manuali e programmabili

Le docce sono dotate di un comando manuale touch, per la gestione di programmi e singoli getti.

Doccino incorporato

Per completamento la doccia orizzontale Zenit è dotata anche di un doccino incorporato.

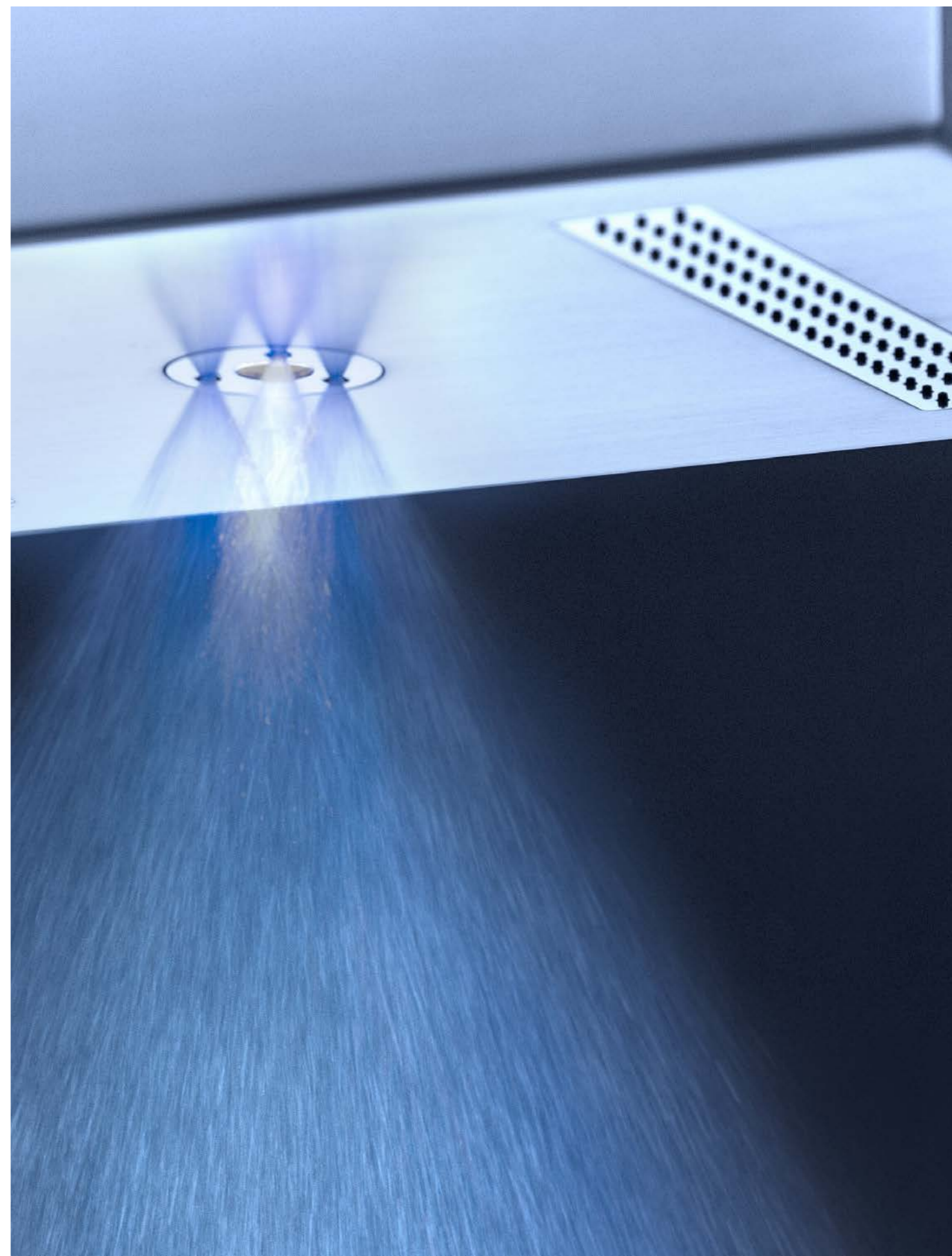

MASSAGE ZONE

The horizontal shower uses the effect of rain water to stimulate the different areas of the body, water coming down onto the skin with variable intensity allows for different treatments, such as a deep body scrub or a nebulized one. Jets and lights are adjusted to different temperatures and colours to achieve targeted firming, toning and circulatory stimulation effects.

ZONE DI MASSAGGIO

La doccia orizzontale sfrutta l'effetto dell'acqua a pioggia per stimolare le diverse zone del corpo, l'acqua, scendendo sulla pelle con intensità variabile, consente di effettuare diversi trattamenti, come uno scrub corpo profondo oppure un nebulizzato. Getti e luci vengono regolati a diverse temperature e colori per ottenere effetti mirati di rassodamento, tonificazione, stimolazione circolatoria.

A.
Cervical area
Zona cervicale

B.
Dorsal area
Zona dorsale

C.
Sacral area
Zona sacrale

C.
Leg area
Zona gambe

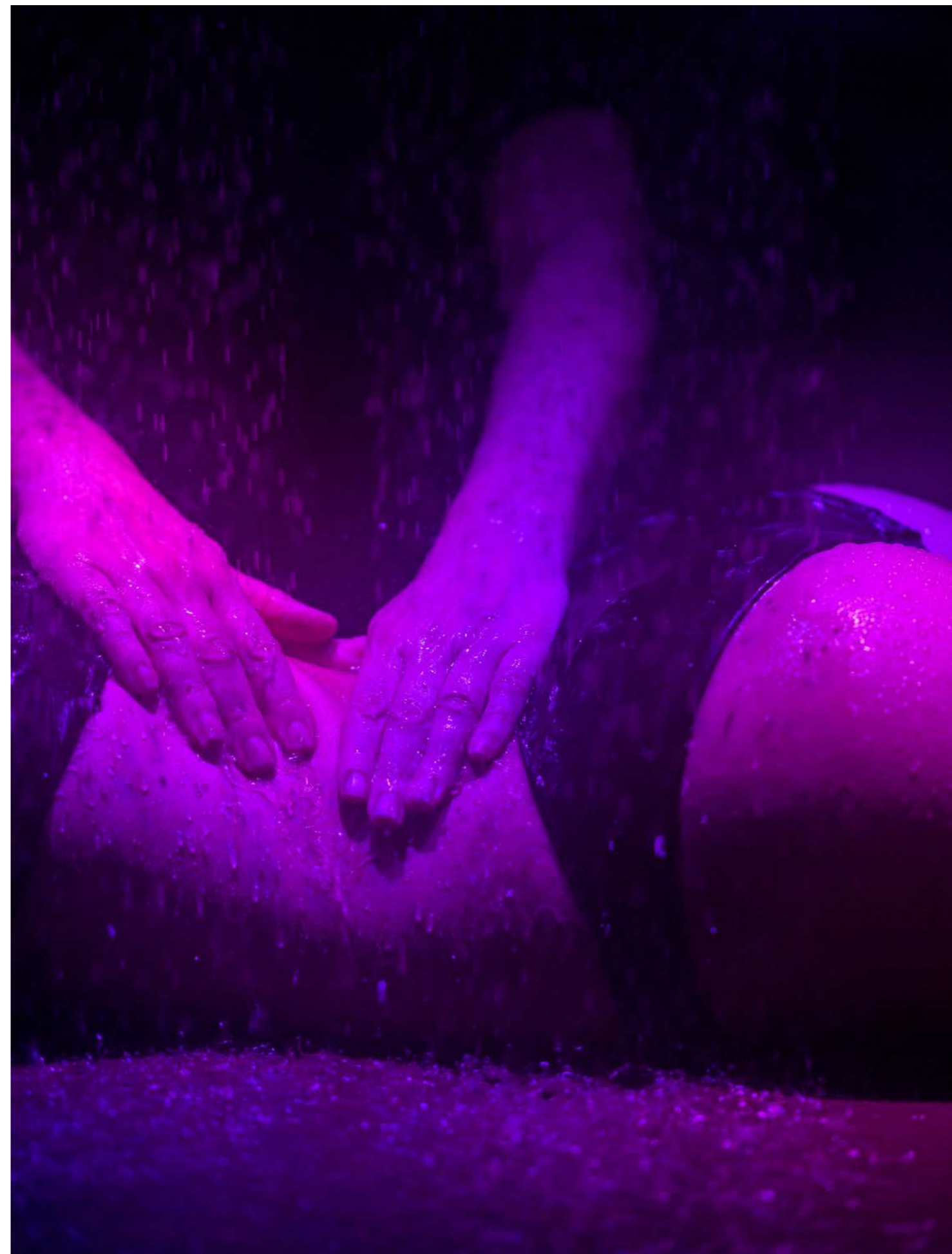
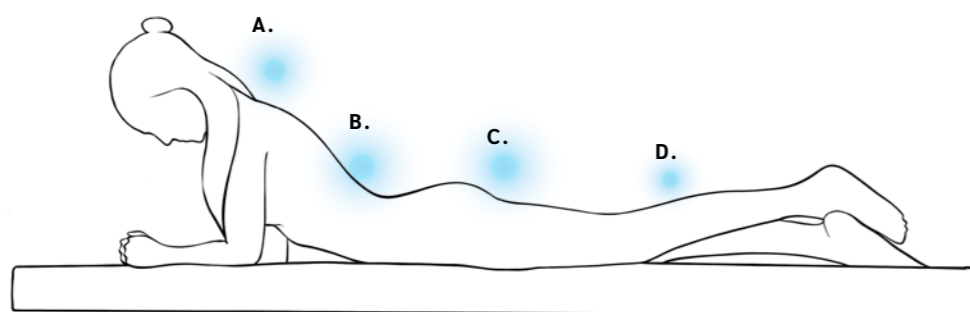

BENEFITS

Evolution of the VICHY shower, the aquaform Aquamotus, Af fusion, Zenit and Nadir horizontal showers are also equipped with a manual touch screen control for automatic or manual management of the different massages and sensorial programs.

BENEFICI

Evoluzione della doccia VICHY, le docce orizzontali Aquamotus, Af fusion, Zenit e Nadir di aquaform sono provviste anche di comandi touch per la gestione automatica o manuale di vari programmi massaggio sensoriali.

**HORIZONTAL SHOWER****Muscular system**

Thanks to its numerous water jets programmed electronically, horizontal shower can exploit the effect of water spraying in a unique way to stimulate and tone tissues whilst originating a deep relaxation at the same time. The water jets flow over your skin in variable sequences, intensities and temperatures, for an extensive interaction with every part of the body.

Sistema muscolare

Grazie ai numerosi getti d'acqua programmati elettronicamente, le docce orizzontali sfruttano in modo unico l'effetto dell'acqua a pioggia per stimolare e tonificare i tessuti e al contempo rilassare profondamente. I getti d'acqua scorrono sulla pelle con sequenze, intensità e temperature variabili, per una capillare interazione con ogni parte del corpo.

**Nervous system**

Colours, aromas and melodies matching the water massage enhance the benefits on the nervous system, thus positively affecting the mind, fostering emotions and feelings of wellbeing.

Sistema nervoso

L'abbinamento del massaggio ad acqua a colori, aromi e melodie ne accentua i benefici sul sistema nervoso, influenzando positivamente sulla psiche, alimentando emozioni e sensazioni di benessere.

**Lymphatic circulation**

In addition to massaging, water pressure stimulates the lymphatic circulation, increases cell oxygenation, drains the tissues and facilitates the elimination of toxins, thus making legs feel lighter and counteracting the effects of cellulites.

Circolazione linfatica

La pressione dell'acqua, oltre a massaggiare, stimola la circolazione linfatica, aumenta l'ossigenazione delle cellule, drena i tessuti, facilitando l'eliminazione delle tossine e consentendo, così, di eliminare la pesantezza alle gambe e di contrastare gli effetti della cellulite.

**Neuro-vegetative system**

Each jets acts with an intense and soothing epithelial micro-massage through the skin's subtle reflexes, which stimulates the neuro-vegetative system allowing the nerve endings to release tensions, as your body and mind relax and realign, regenerating the whole organism with a greatly effective de-stress action comparable to manual massages only.

Sistema neurovegetativo

Ciascun getto agisce con un intenso e distensivo micromassaggio epiteliale tramite i fini riflessi cutanei, viene così stimolato il sistema neurovegetativo, permettendo alle terminazioni nervose di liberare le tensioni, corpo e mente si distendono e si riallineano rigenerando l'intero organismo con un'azione antistress di grande efficacia paragonabile solo al massaggio manuale.

**Cellular regeneration**

Fast cell regeneration detoxifies and oxygenises the tissues, with purifying effects under the skin too, for a deep overall anti-aging action.

Rigenerazione cellulare

La veloce rigenerazione delle cellule, fa sì che i tessuti risultino detossinati e ossigenati, generando benefici purificativi anche a livello sottocutaneo, per un'azione no-age profonda e globale.



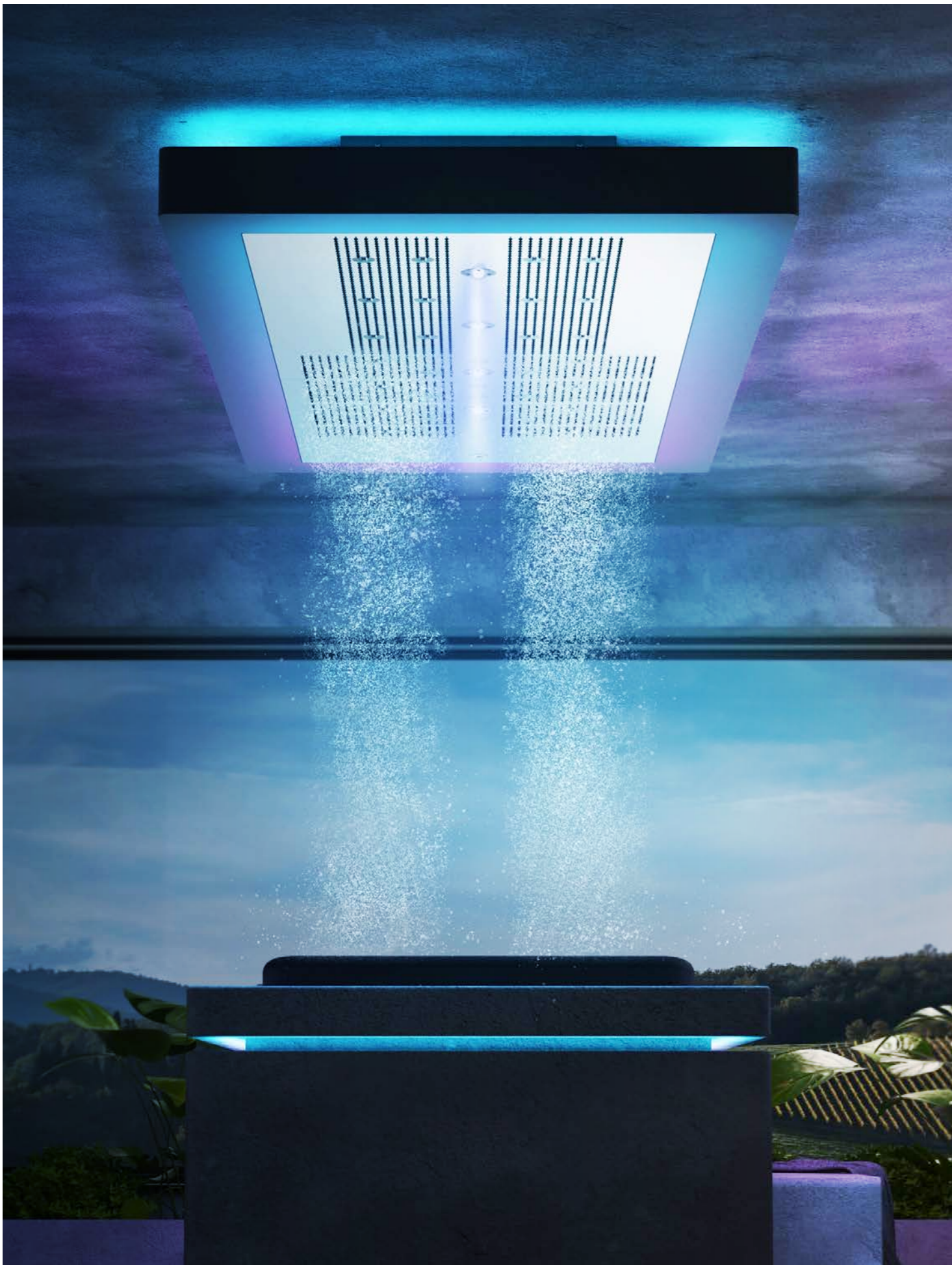

HORIZONTAL SHOWER



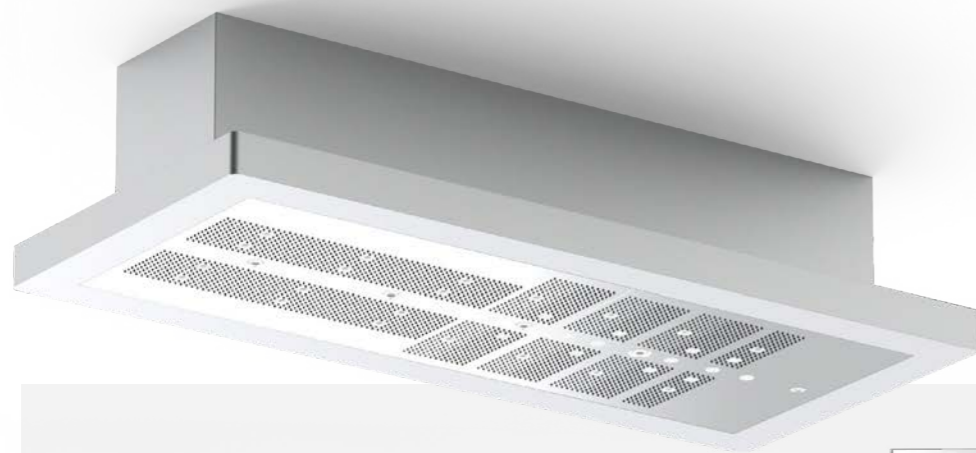

AQUAMOTUS

Evolution of the vichy shower, aquamotus is a professional horizontal shower for the reproduction of 16 types of massage in the rain.

Evoluzione della doccia vichy, aquamotus è una doccia orizzontale di tipo professionale per la riproduzione di 16 tipologie di massaggio sotto pioggia.

Features / Caratteristiche

5 types of jets	5 tipologie di getti
35 solenoid valves	35 elettrovalvole
16 programs	16 programmi
50 combinations	50 combinazioni
2 finishes	2 finiture
4 heights	4 altezze
4 types of fixing	4 tipologie di fissaggio
4.3 " touch screen	4,3" touch screen
Ceiling application	Applicazione a soffitto
Chromotherapy	Cromoterapia
Manual use	Utilizzo in manuale



⊕ x 1

▲ x 4

⊗ x 6

⊗ x 8

⊕ x 8

▲ x 12

⊕ x 6

⊗ x 4

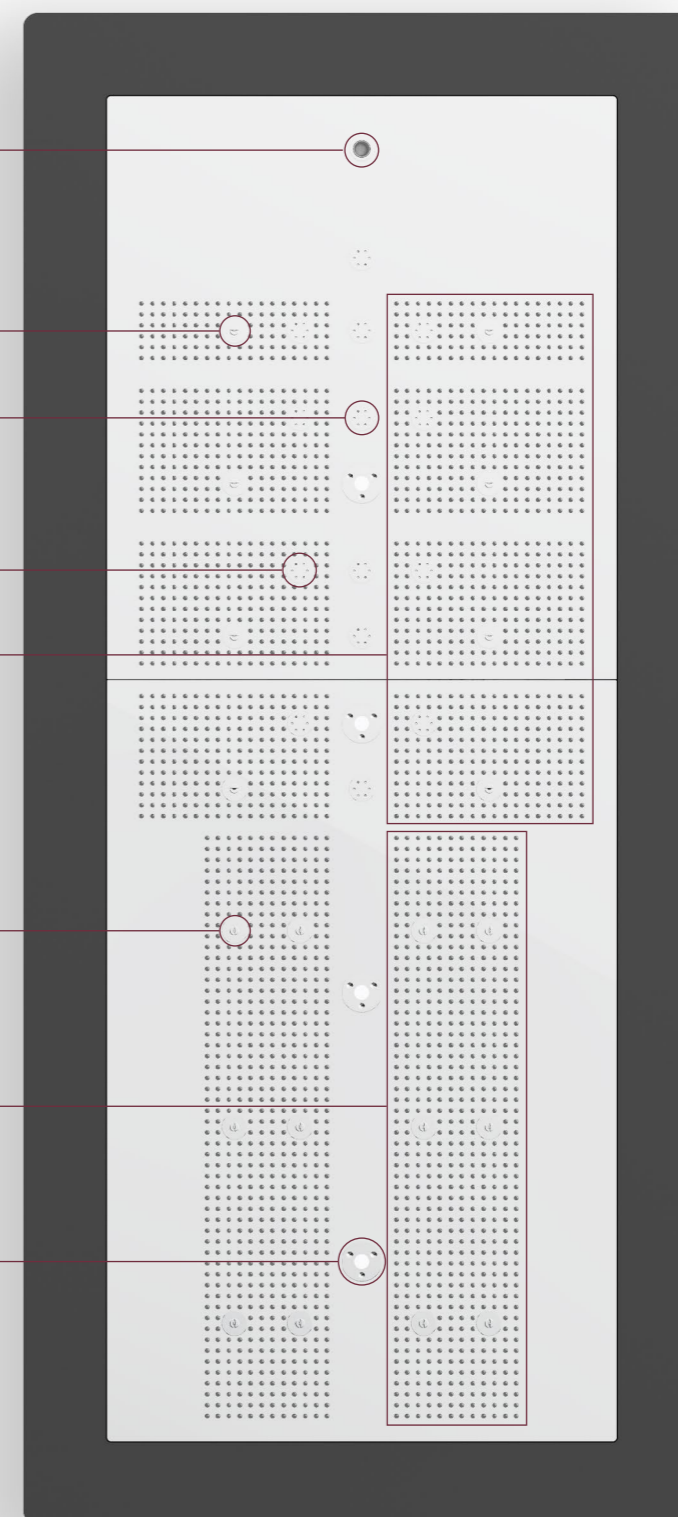

A.
Cervical area
Zona cervicale

B.
Dorsal area
Zona dorsale

C.
Sacral area
Zona sacrale

C.
Leg area
Zona gambe

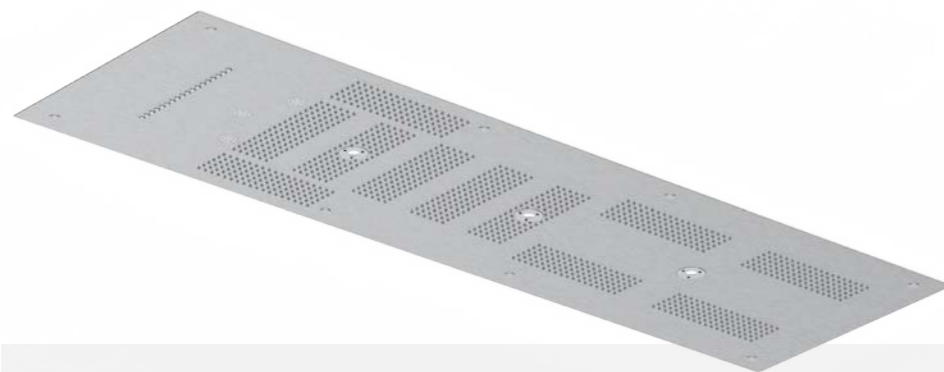

AF FUSION



Horizontal ceiling shower with 4 automatic programs and the possibility to manually select the jets.

Doccia orizzontale a soffitto con 4 programmi automatici e la possibilità di selezionare manualmente i getti.

Features / Caratteristiche

4 types of jets	4 getti
4 programs	4 programmi
10 combinations	10 combinazioni
3 finishes	3 finiture
4.3 " touch screen	4,3" touch screen
Ceiling application	<i>Applicazione a soffitto</i>
Chromotherapy	<i>Cromoterapia</i>
Manual use	<i>Utilizzo in manuale</i>



 x 1

 x 3

 x 11

 x 3

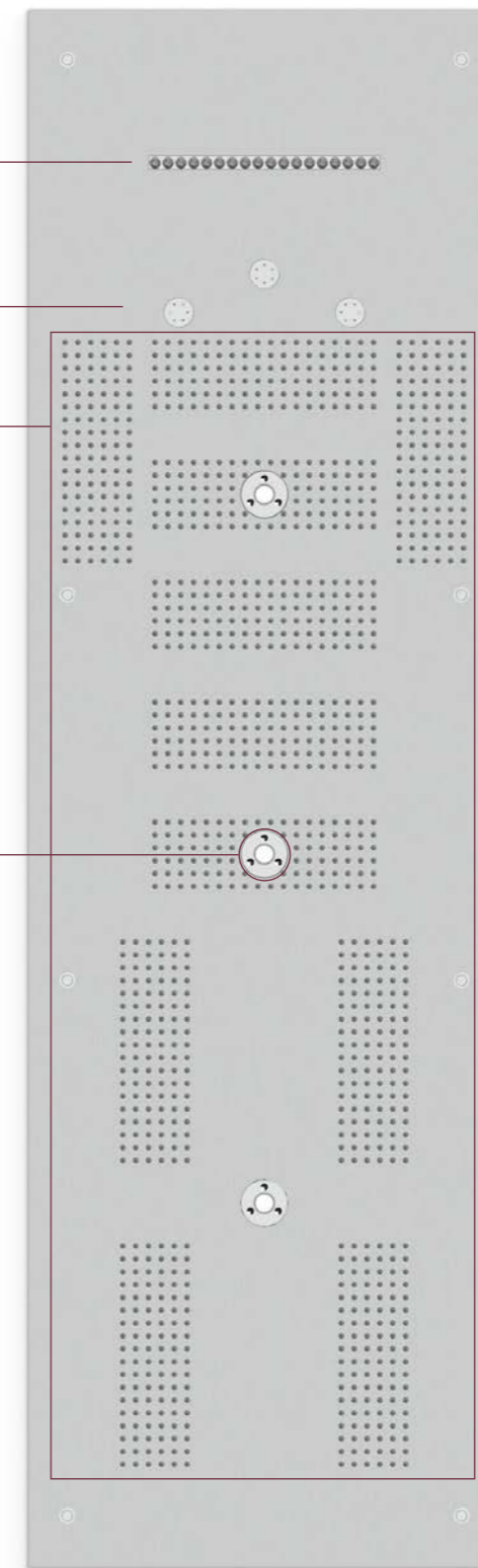

A.
Cervical area
Zona cervicale

B.
Dorsal area
Zona dorsale

C.
Sacral area
Zona sacrale

C.
Leg area
Zona gambe



NADIR

Horizontal ceiling shower with 4 automatic programs and the possibility to manually select the jets.

Doccia orizzontale a soffitto con 4 programmi automatici e la possibilità di selezionare manualmente i getti.

Features / Caratteristiche

2 types of jets	2 getti
4 programs	4 programmi
10 combinations	10 combinazioni
3 finishes	3 finiture
4.3 " touch screen	4,3" touch screen
Ceiling application	Applicazione a soffitto
Chromotherapy	Cromoterapia
Manual use	Utilizzo in manuale

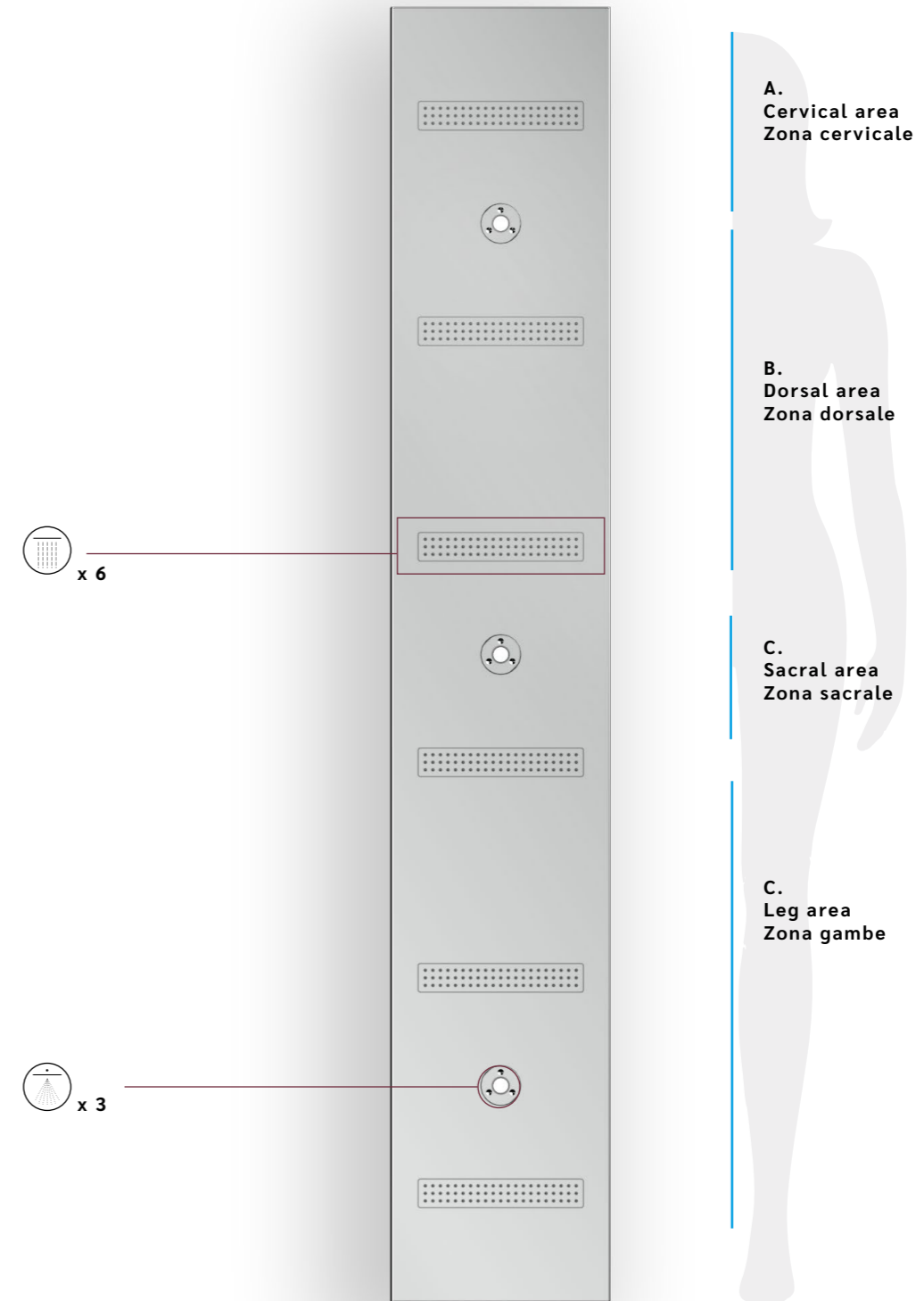
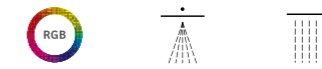



ZENIT

Horizontal wall shower with 4 automatic programs and the possibility to manually select the jets.

Doccia orizzontale da parete con 4 programmi automatici e la possibilità di selezionare manualmente i getti.

Features / Caratteristiche

2 types of jets	2 getti
4 programs	4 programmi
10 combinations	10 combinazioni
3 finishes	3 finiture
4.3" recessed touch	4,3" touch incorporato
Wall application	Applicazione a parete
Chromotherapy	Cromoterapia
Manual use	Utilizzo in manuale
Shower included	Doccino incluso

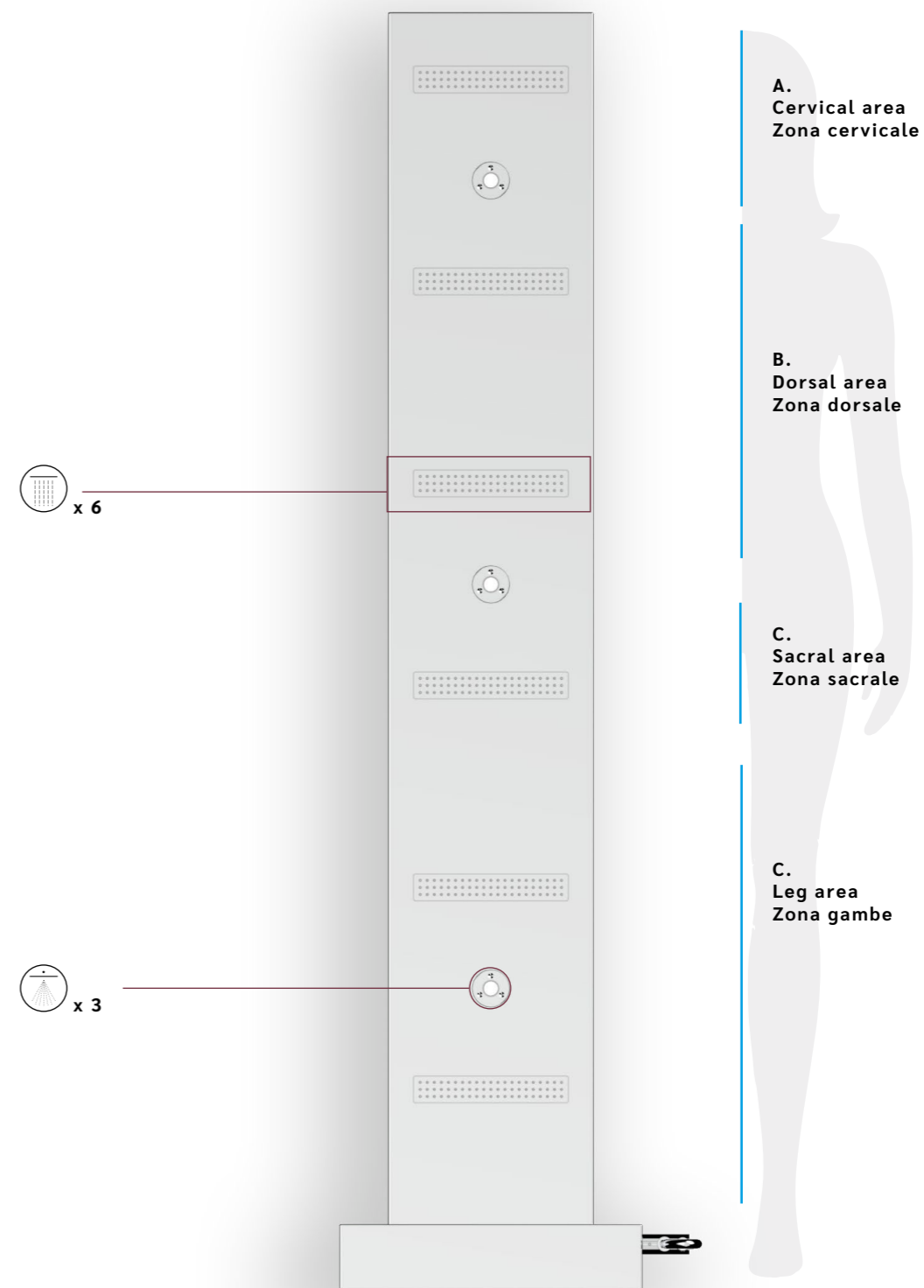
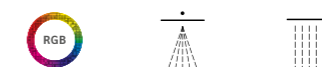

MODULAR SHOWERHEADS

/ SOFFIONI MODULARI

LIBERA

LET YOUR IMAGINATION RUN FREE.
LASCIARE LIBERO SFOGO ALLA FANTASIA.

Libera is a system of modular showers, which allows customers to unleash their imagination, personally composing their own shower according to specific needs and desires. The system is formed by a series of modules, diversified in water jets and lights, and available in different finishes.

Libera è un percorso modulare, che consente di dare libero sfogo alla propria fantasia, componendo personalmente la propria emotional SPA secondo esigenze e desideri specifici. Il sistema è composto di una serie di moduli, diversificati tra getti d'acqua e luce, disponibili in varie finiture.

FEATURES**CARATTERISTICHE****Composition**

Total freedom of composition to obtain all the desired emotional paths.

Composizione

Totale libertà di composizione per ottenere tutti i percorsi emozionali desiderati.

Finishes

A wide range of finishes available, applied both to the modules and to the recessed case.

Finiture

Numerose finiture disponibili, applicabili sia ai moduli che al telaio da incasso.

Recessed case

aquaform supplies recessed cases of different sizes to contain one to seven modules, for an incomparable scenic effect.

Telaio incasso

aquaform fornisce telai da incasso di diversa taglia per racchiudere da uno a sette moduli, per un effetto scenico senza pari.

Total customization

The organization of Libera in modules guarantees the total customization of the shower and simplifies the work of designers and operators.

Personalizzazione

L'organizzazione per moduli di Libera garantisce la totale personalizzazione della doccia e semplifica il lavoro di progettisti e operatori.



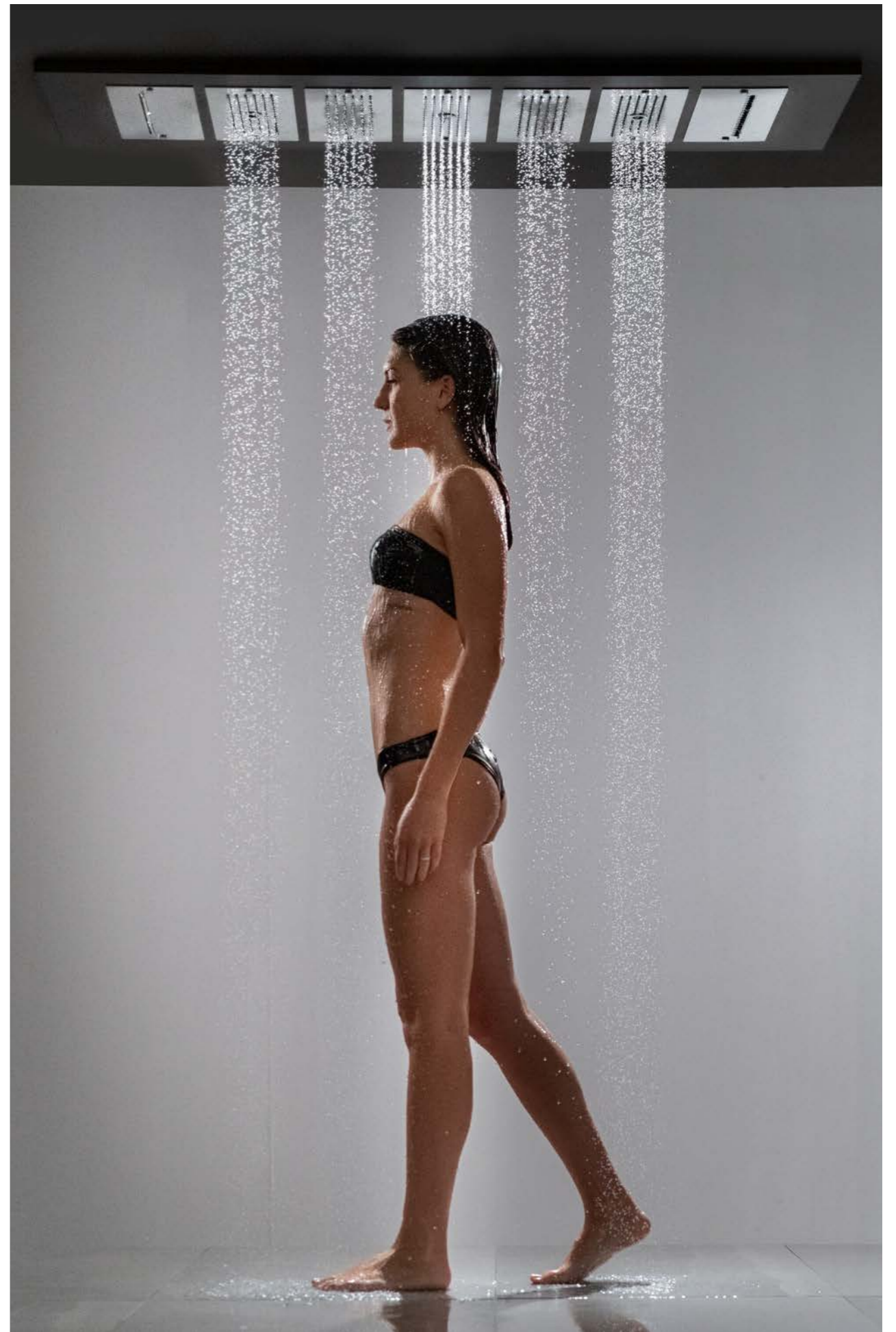



MODULES

With Libera, imagination has no limits and the SPA system is adapted to your every need, guided by your creative inspiration and personal wellness.

It is possible to choose between various compositions and combinations, using from one to seven or more modules, depending on the available space and the desired effects, and choosing from the wide range of options, including different jets, colours and lights.

MODULI

Con Libera la fantasia non conosce limiti e il percorso SPA si adatta a ogni tua esigenza, lasciandosi trasportare dall'estro creativo e dal benessere personale.

È possibile realizzare varie composizioni e combinazioni, utilizzando da uno a sette o più moduli, in base allo spazio disponibile e agli effetti desiderati, e scegliendo dalla vasta gamma di opzioni, tra getti, colori e luci differenti.

LIBERA / R3515C1



Body: 150x350 mm rectangular recessed shower head.
Function: Rain jet and LED spotlight with chromotherapy.
Wet surface: 75x255mm.
 Complete with fixing system.

Corpo: Soffione rettangolare da incasso 150x350 mm.
Funzione: Getto pioggia e faretto LED con cromoterapia.
Superficie bagnata: 75x255mm.
 Completo di sistema di fissaggio.

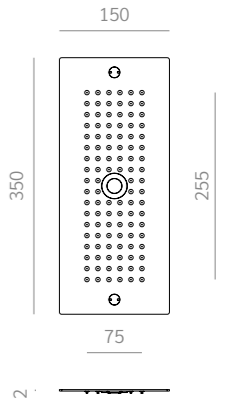

LIBERA / N3515C15



Body: 150x350 mm rectangular recessed shower head.
Function: Rain jet and aerated.
Wet surface: 75x255mm.
 Complete with fixing system.

Corpo: Soffione rettangolare da incasso 150x350 mm.
Funzione: Getto pioggia e aerato.
Superficie bagnata: 75x255mm.
 Completo di sistema di fissaggio.

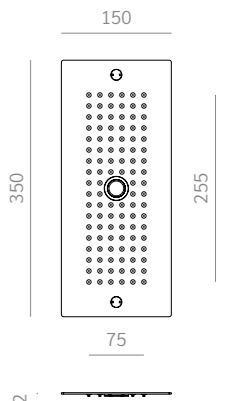

LIBERA / N3515C1

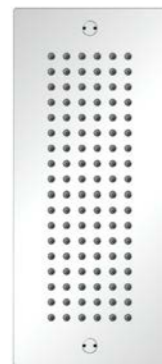

Body: 150x350 mm rectangular recessed shower head.
Function: Rain jet.
Wet surface: 75x255mm.
 Complete with fixing system.

Corpo: Soffione rettangolare da incasso 150x350 mm.
Funzione: Getto pioggia.
Superficie bagnata: 75x255mm.
 Completo di sistema di fissaggio.

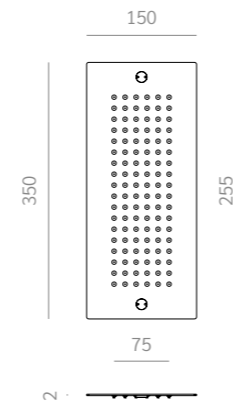

LIBERA / N3515C12



Body: 150x350 mm rectangular recessed shower head.
Function: Rain jet and nebulized.
Wet surface: 75x255mm.
 Complete with fixing system.

Corpo: Soffione rettangolare da incasso 150x350 mm.
Funzione: Getto pioggia e nebulizzato.
Superficie bagnata: 75x255mm.
 Completo di sistema di fissaggio.

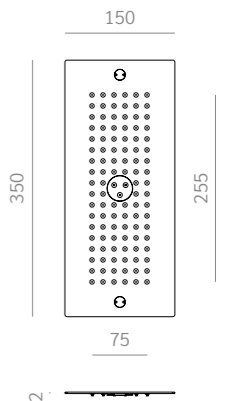

LIBERA / N3515C16



Body: 150x350 mm rectangular recessed shower head.
Function: Rain jet and atomized.
Wet surface: 75x255mm.
 Complete with fixing system.

Corpo: Soffione rettangolare da incasso 150x350 mm.
Funzione: Getto pioggia e atomizzato.
Superficie bagnata: 75x255mm.
 Completo di sistema di fissaggio.

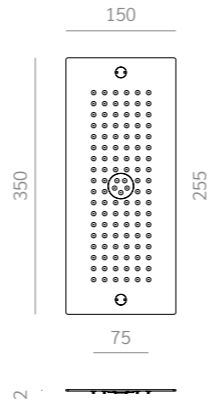

LIBERA / N3515C4



Body: 150x350 mm rectangular recessed shower head.
Function: Waterfall.
 Complete with fixing system.

Corpo: Soffione rettangolare da incasso 150x350 mm.
Funzione: Cascata.
 Completo di sistema di fissaggio.

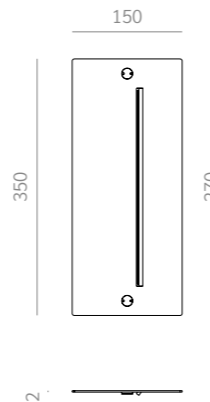

LIBERA / N3515C3A



Body: 150x350 mm rectangular recessed shower head.
Function: Tropical aerated.
 Complete with fixing system.

Corpo: Soffione rettangolare da incasso 150x350 mm.
Funzione: Tropicale aerato.
 Completo di sistema di fissaggio.

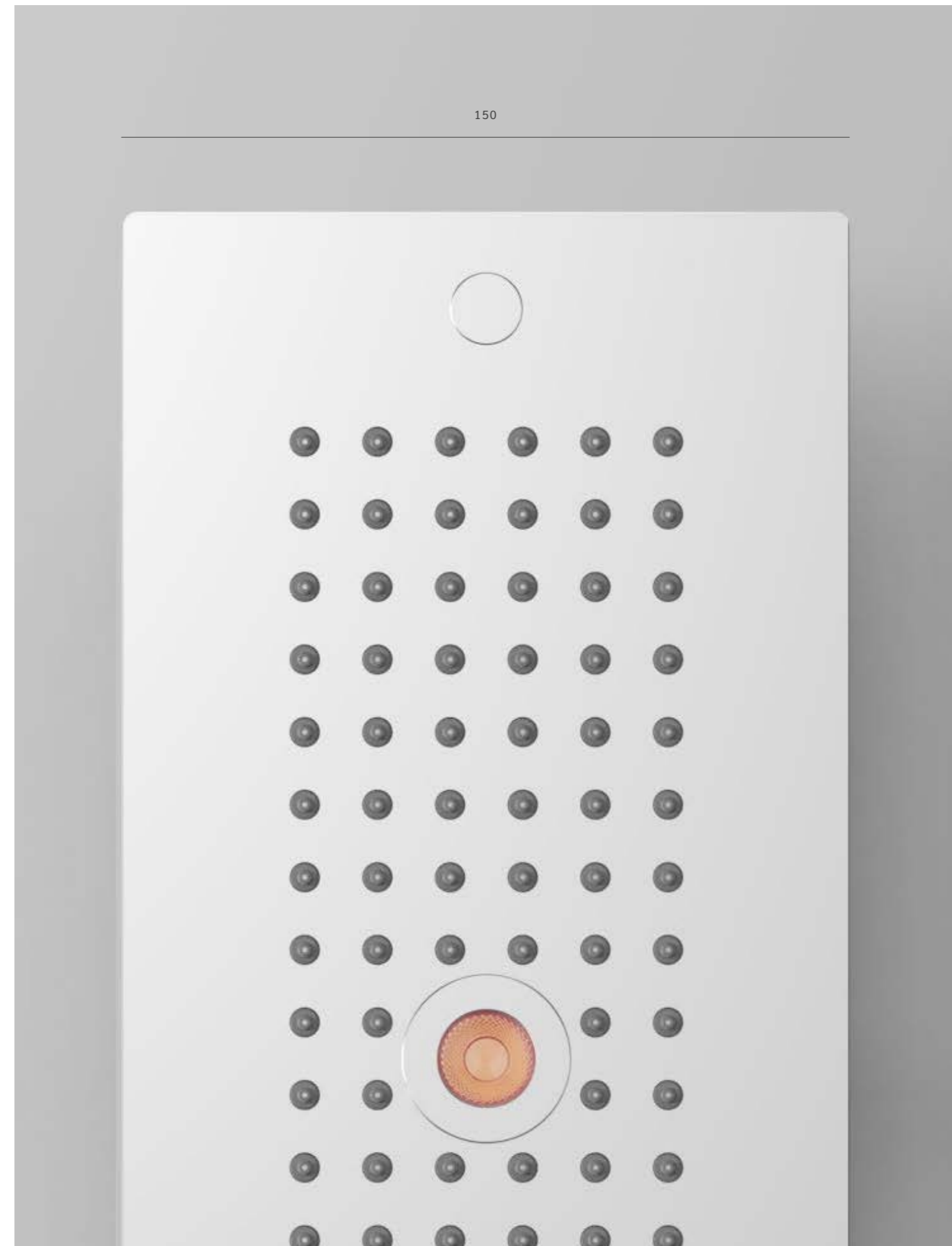
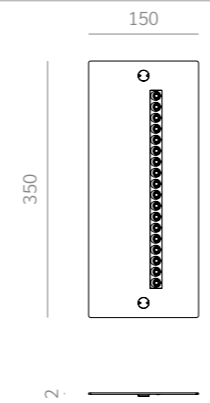

150

CASING

The modules of the Libera can be pre-installed on a frame of various finishes and sizes, so as to facilitate installation and laying.

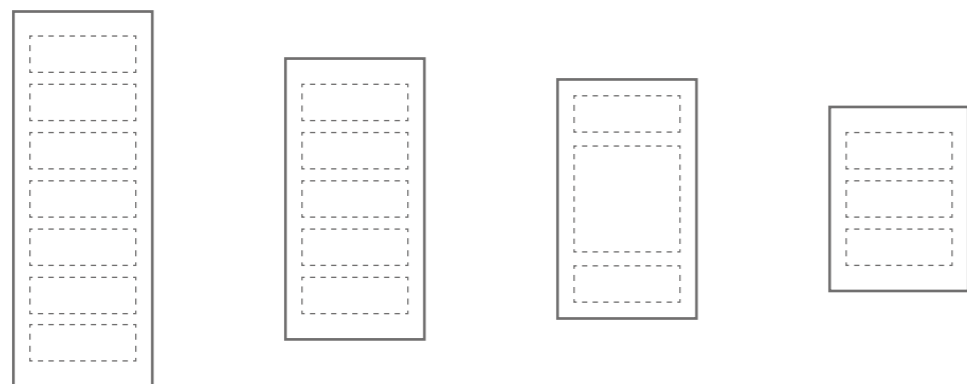

Dimensions / Dimensione



Compositions / Composizioni



Finishes / Finiture



Marble



Metal



Colour



Wood

LIBERA

TELAIO

I moduli della serie Libera possono essere preinstallati su di un telaio di varie finiture e dimensioni, in modo da facilitare l'installazione e la posa.

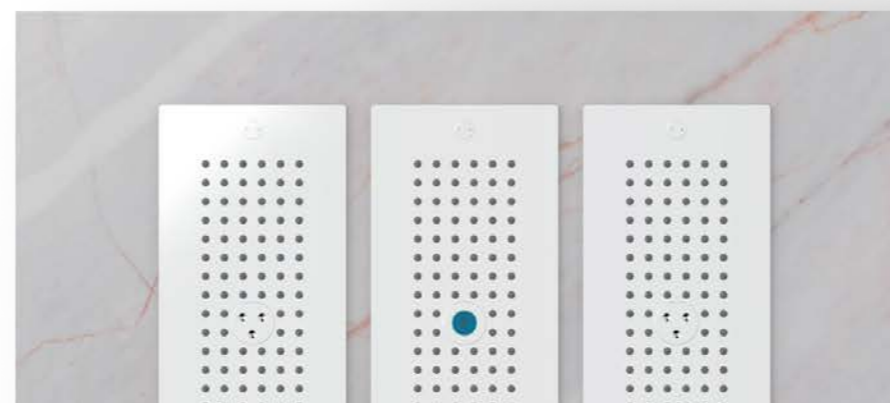
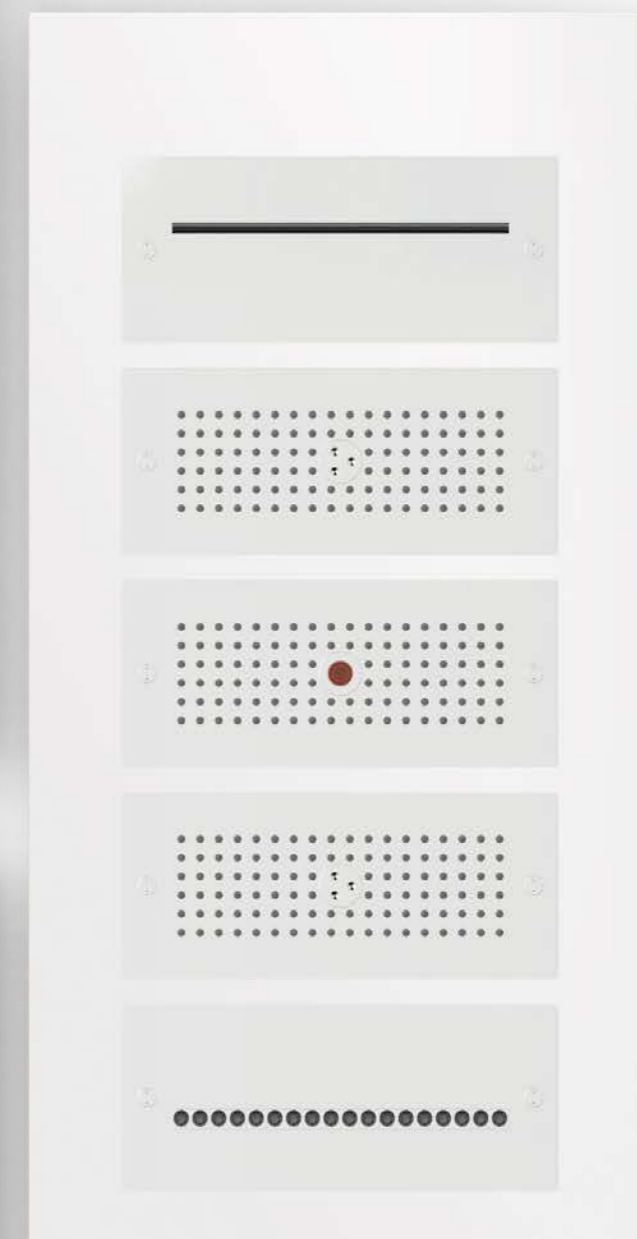
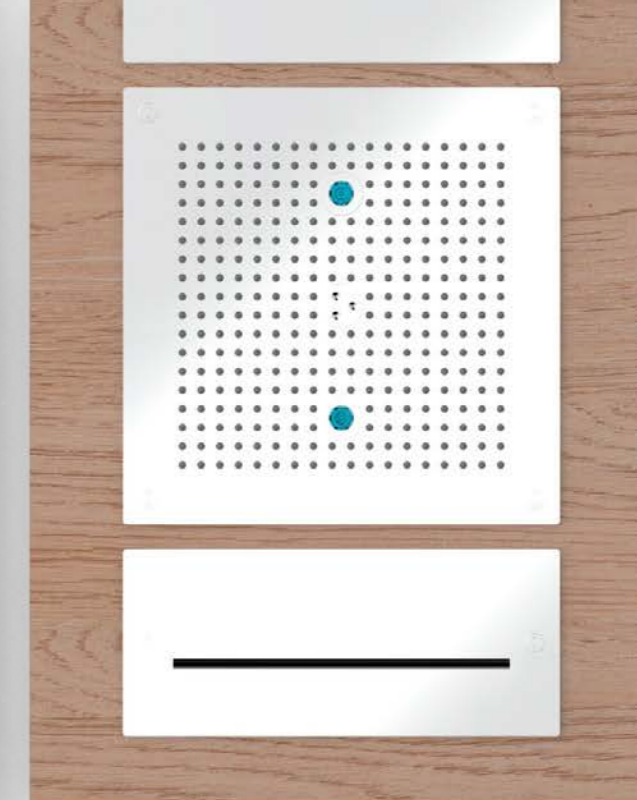
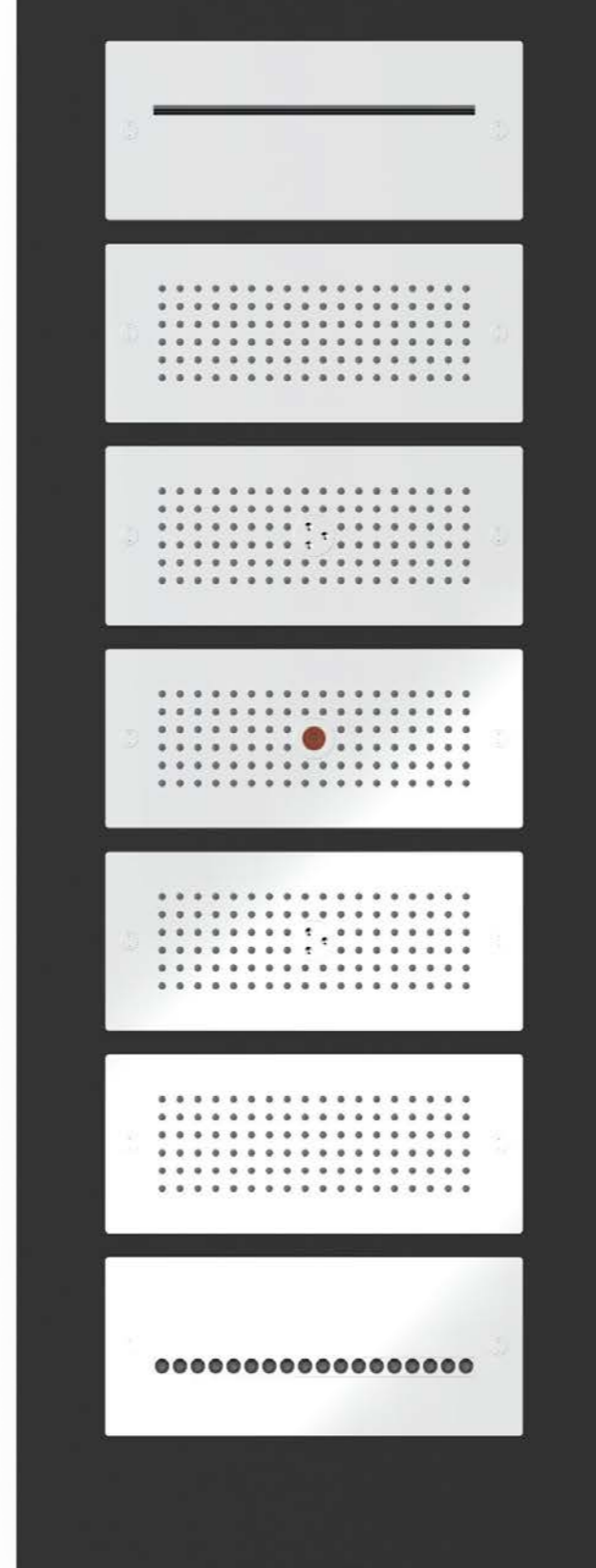

EXAMPLES / ESEMPI

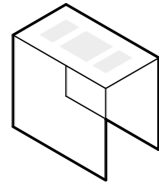

Composition 01
Suite SPA

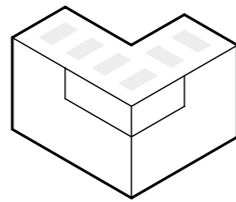

Composition 02
Emotional tunnel

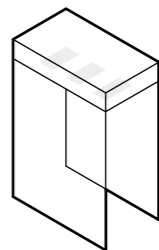

Composition 03
Private SPA with case

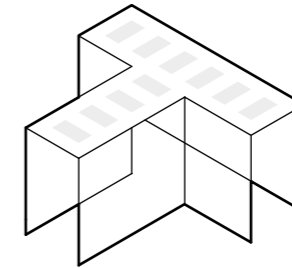

Composition 04
Custom Tunnel SPA

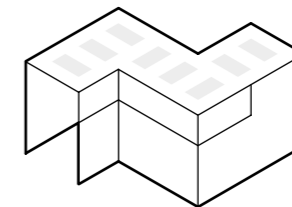

Composition 05
S Tunnel Custom Private

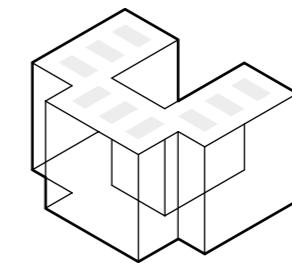

Composition 06
Multi-sensory Tunnel

SHOWERHEADS WITH WHITE LIGHT

/ SOFFIONI CON LUCE BIANCA

LUMINA

REGENERATING MIX OF WATER AND LIGHT.
COMMISTIONE RIGENERANTE TRA ACQUA E LUCE.

The Lumina series proposes to brighten up the bathroom environment, spreading its pure white light even in those corners where it usually doesn't reach. The LED lights mounted inside the compartment are perfectly integrated with the surrounding environment and provide a soft illumination, thus transforming the atmosphere.

La serie Lumina propone di rendere luminoso l'ambiente del bagno, spandendo la sua luce bianca e pura anche in quegli angoli in cui solitamente non arriva. Le luci al LED inserite nel vano sono perfettamente integrate con l'ambiente circostante e provvedono a illuminarlo delicatamente, trasformandone l'atmosfera.

FEATURES**Minimum flow rate**

The showerheads are designed to work perfectly even with low-pressure systems.

Warm and cold light

The White LED technology allows to choose between a warm (3000 K) or cold (6000 K) light.

Spotlight + H2O

aquaform innovates the SPA path through the fusion of light and water in a single body with reduced dimensions.

IP67

Our products are all certified IP 67, guaranteeing a complete and safe protection to all electrical components.

CARATTERISTICHE**Portata minima**

I prodotti sono pensati per funzionare perfettamente anche con impianti a bassa pressione.

Luce calda e fredda

La tecnologia LED White permette di scegliere tra una luce calda (3000 K) o fredda (6000 K).

Faretto + H2O

aquaform innova il percorso SPA tramite la fusione di luce e acqua in un unico corpo dalle dimensioni ridotte.

IP67

I nostri prodotti sono tutti certificati IP 67, garantendo una protezione completa e sicura a tutti i componenti elettrici.

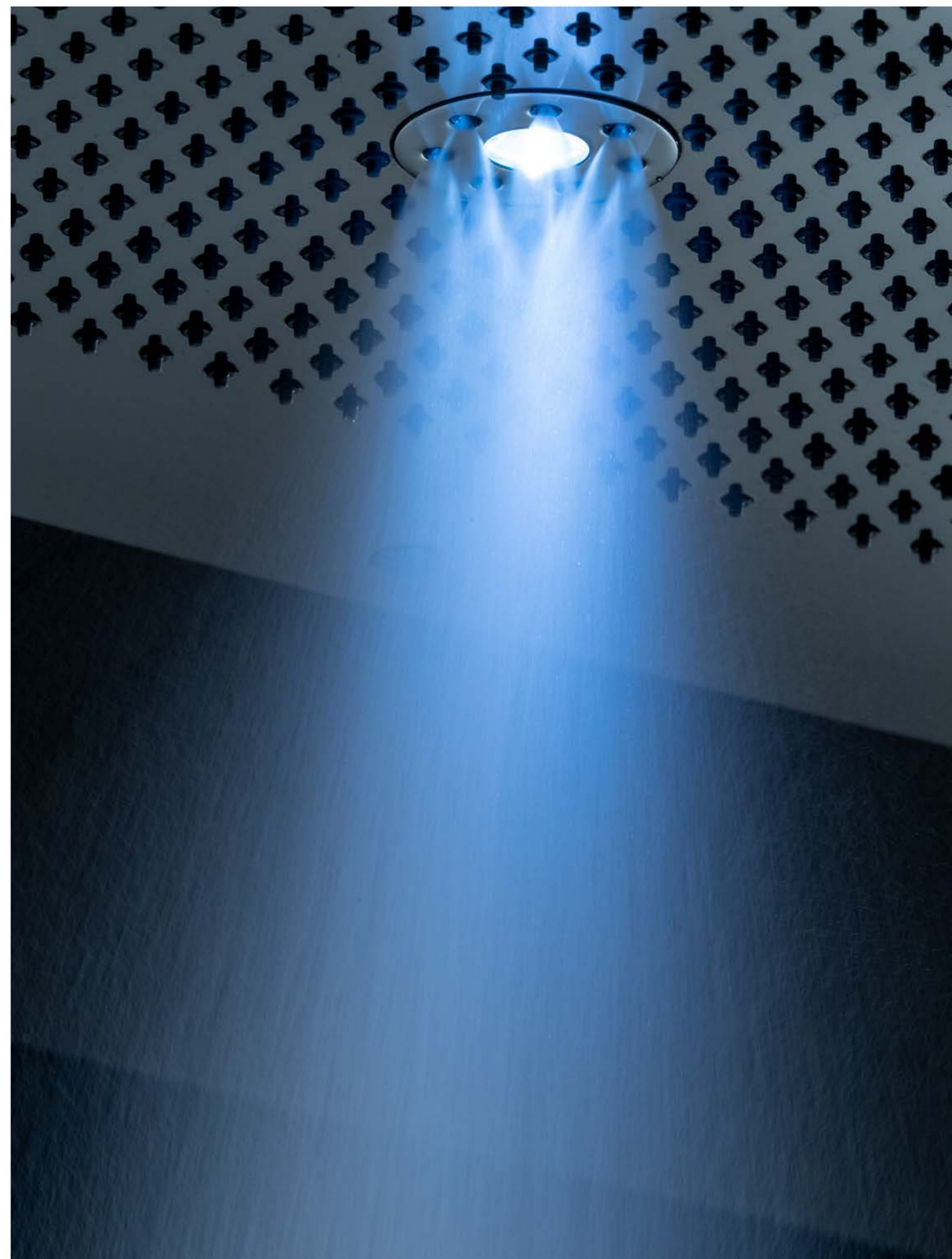

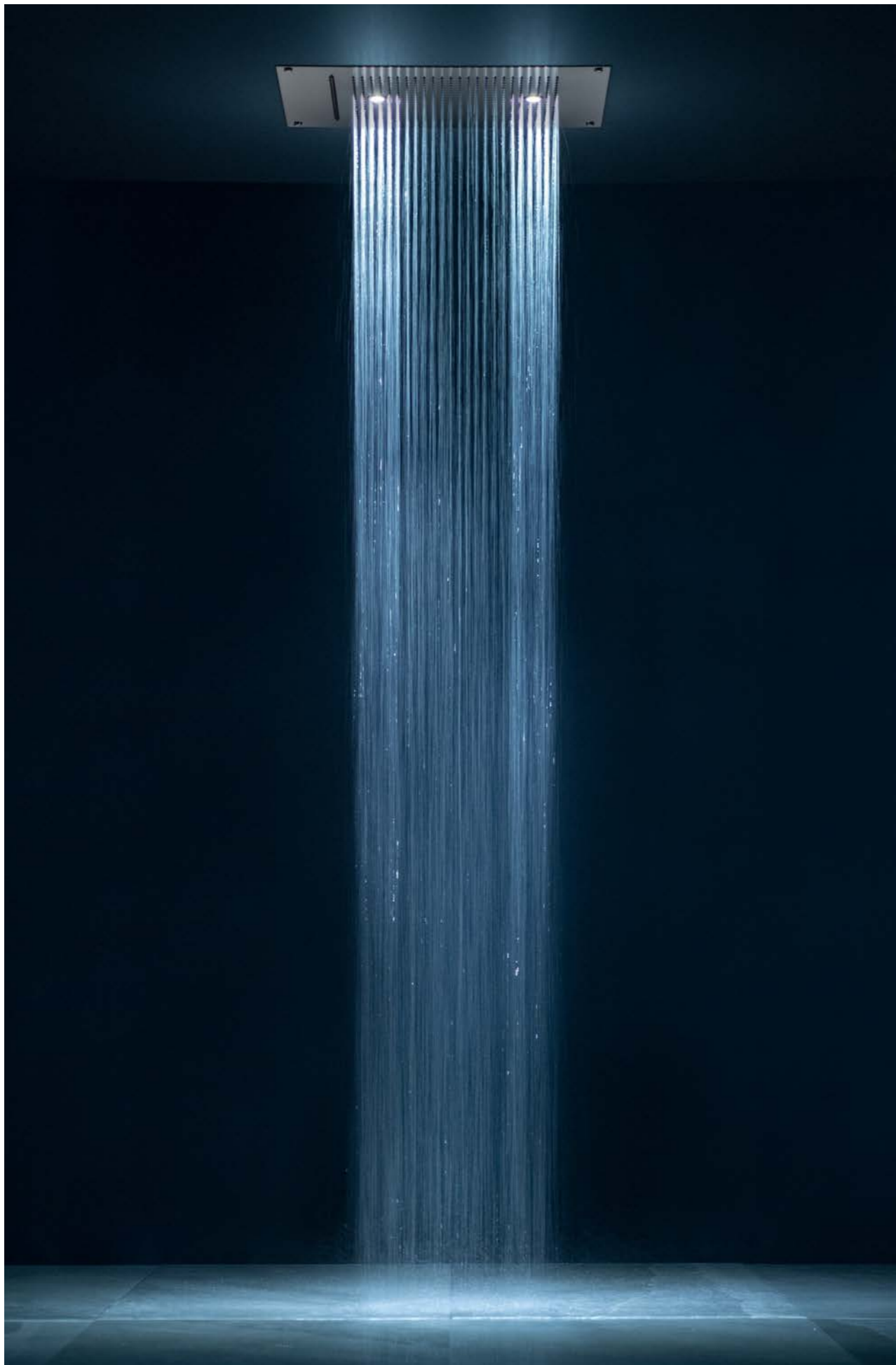

LUMINA

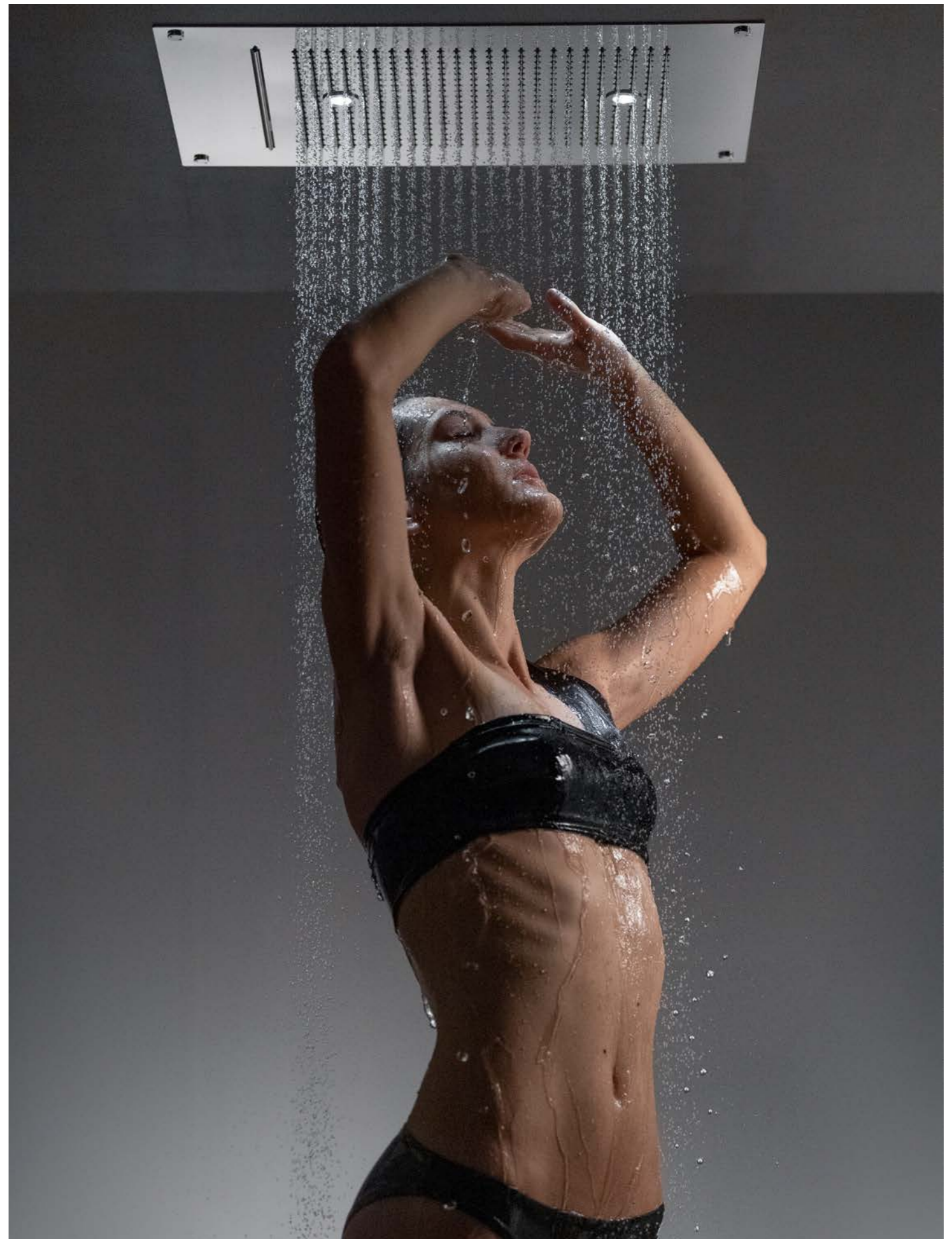



Warm light 3000 K

/ Luce calda 3000 K

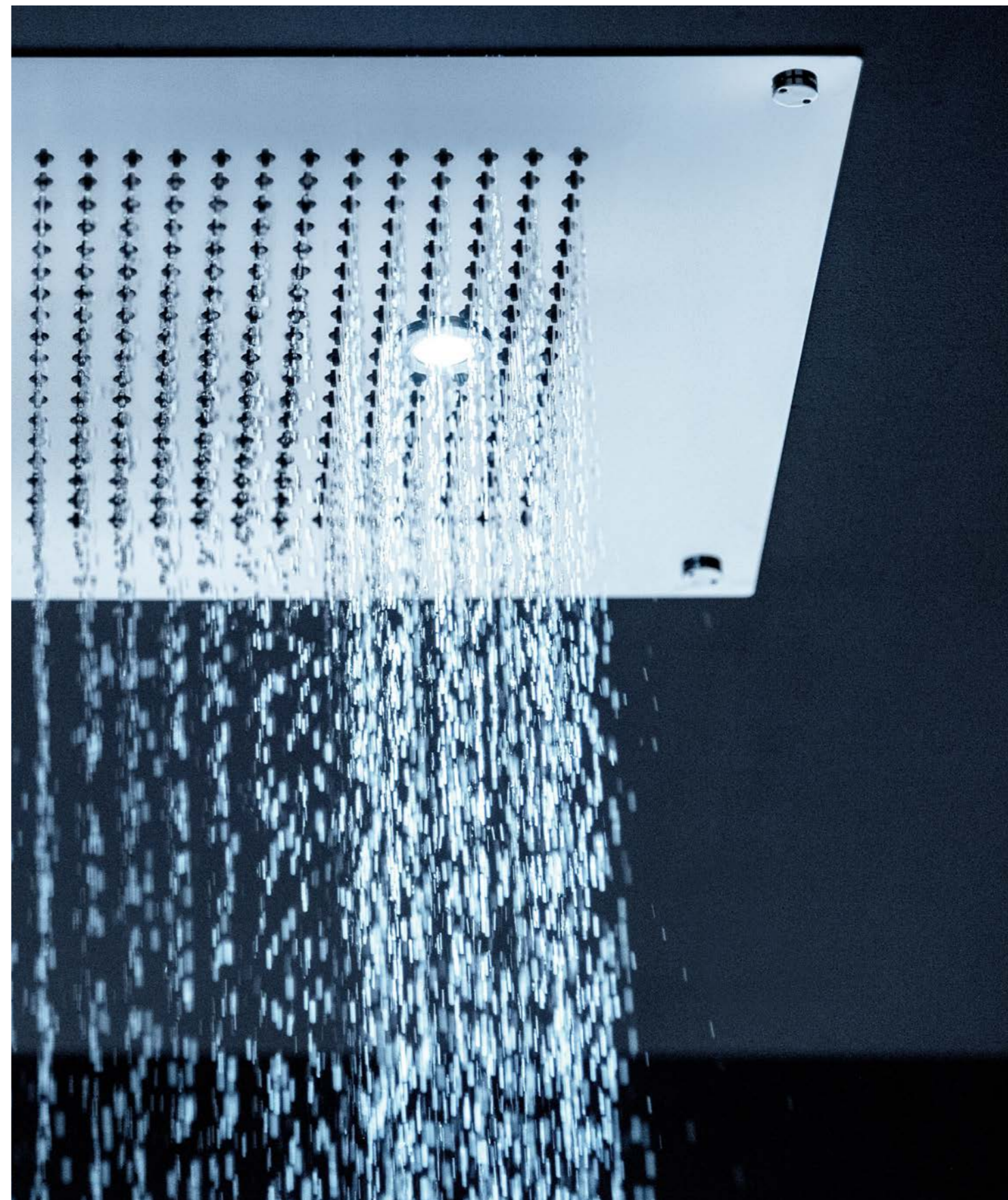

Cold light 6000 K

/ Luce fredda 6000 K



LUMINA / W70C1234

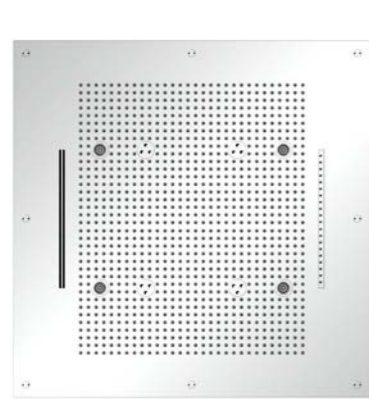

Body: 700X700 mm square recessed shower head.
Function: Rain jet, waterfall, 4 nebulized, 1 tropical and 4 LED spotlights with white light.
Wet surface: 435x525mm.
Recessed: 100 mm.
 Complete with fixing system.

Corpo: Soffione quadro da incasso 700X700 mm.
Funzione: Getto pioggia, cascata, 4 nebulizzati, 1 tropicale e 4 faretti LED con luce bianca.
Superficie bagnata: 435x525mm.
Incasso: 100 mm.
 Completo di sistema di fissaggio.

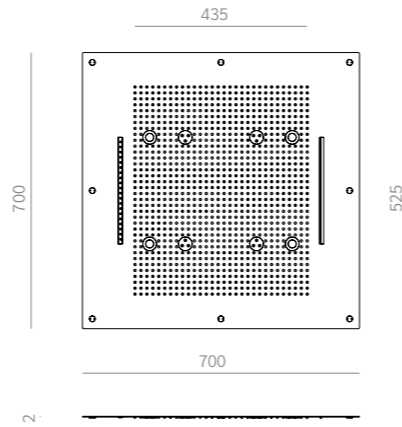

LUMINA / W5638C12



Body: 560X380 mm rectangular recessed shower head.
Function: Rain jet, 2 nebulized and 2 LED spotlights with white light.
Wet surface: 435x255mm.
Recessed: 100 mm.
 Complete with fixing system.

Corpo: Soffione rettangolare da incasso 560X380 mm.
Funzione: Getto pioggia, 2 Nebulizzati e 2 faretti LED con luce bianca.
Superficie bagnata: 435x255mm.
Incasso: 100 mm.
 Completo di sistema di fissaggio.

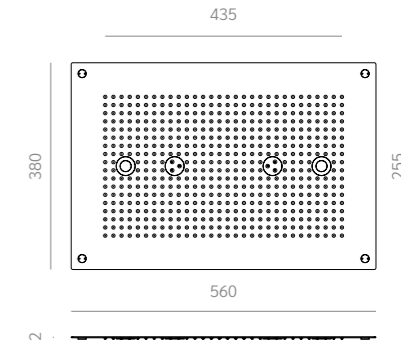

LUMINA / W70C1

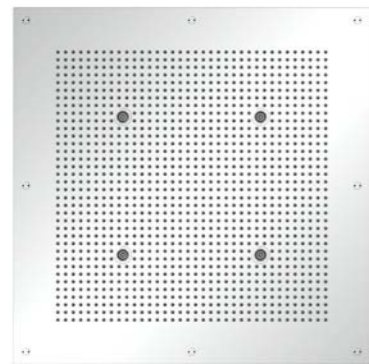

Body: 700X700 mm square recessed shower head.
Function: Rain jet and 4 led spotlights with white light.
Wet surface: 525x525mm.
Recessed: 100 mm.
 Complete with fixing system.

Corpo: Soffione quadro da incasso 700X700 mm.
Funzione: Getto pioggia e 4 faretti led con luce bianca.
Superficie bagnata: 525x525mm.
Incasso: 100 mm.
 Completo di sistema di fissaggio.

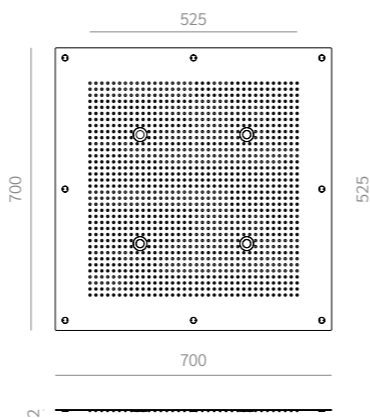

LUMINA / WT35C12

NEW



Body: Ø 350 mm round recessed shower head.
Function: Rain jet, nebulized and 3 LED spotlights with white light.
Wet surface: Ø 250 mm.
Recessed: 100 mm.
 Complete with fixing system.

Corpo: Soffione tondo da incasso Ø 350 mm.
Funzione: Getto pioggia, nebulizzato e 3 faretti LED con luce bianca.
Superficie bagnata: Ø 250 mm
Incasso: 100 mm.
 Completo di sistema di fissaggio.

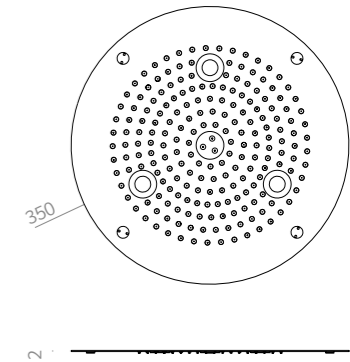

LUMINA / W7048C14

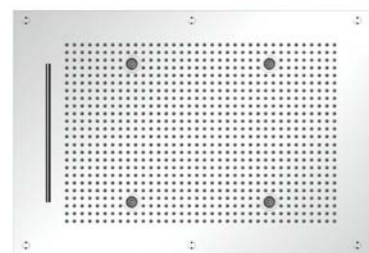

Body: 700x480 mm rectangular recessed shower head.
Function: Rain jet, waterfall and 4 LED spotlights with white light.
Wet surface: 525x345mm.
Recessed: 100 mm.
 Complete with fixing system.

Corpo: Soffione rettangolare da incasso 700x480 mm.
Funzione: Getto pioggia, cascata e 4 faretti LED con luce bianca.
Superficie bagnata: 525x345mm.
Incasso: 100 mm.
 Completo di sistema di fissaggio.

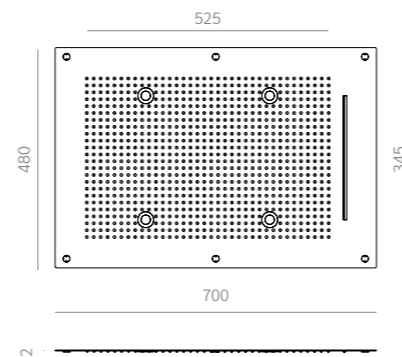

LUMINA / W42C14



Body: 420x420 mm square recessed shower head.
Function: Rain jet, waterfall and 2 LED spotlights with white light.
Wet surface: 255x255mm.
Recessed: 100 mm.
 Complete with fixing system.

Corpo: Soffione quadro da incasso 420x420 mm.
Funzione: Getto pioggia, cascata e 2 faretti LED con luce bianca.
Superficie bagnata: 255x255mm.
Incasso: 100 mm.
 Completo di sistema di fissaggio.

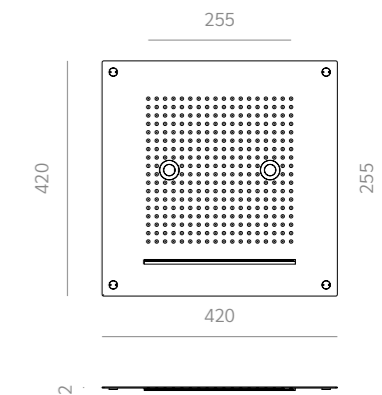
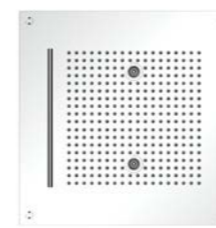

LUMINA / W35C12

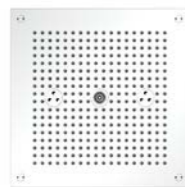

Body: 350x350 mm square recessed shower head.
Function: Rain jet, 2 nebulized and 1 LED spotlight with white light.
Wet surface: 255x255mm.
Recessed: 100 mm.
 Complete with fixing system.

Corpo: Soffione quadro da incasso 350x350 mm.
Funzione: Getto pioggia, 2 nebulizzati e 1 faretto LED con luce bianca.
Superficie bagnata: 255x255mm.
Incasso: 100 mm.
 Completo di sistema di fissaggio.

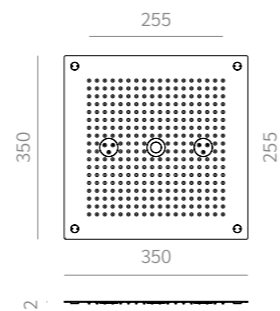

LUMINA / W35C1

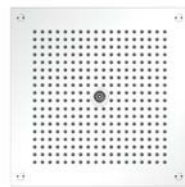

Body: 350x350 mm square recessed shower head.
Function: Rain jet and 1 LED spotlight with white light.
Wet surface: 255x255mm.
Recessed: 100 mm.
 Complete with fixing system.

Corpo: Soffione quadro da incasso 350x350 mm.
Funzione: Getto pioggia e 1 faretto LED con luce bianca.
Superficie bagnata: 255x255mm.
Incasso: 100 mm.
 Completo di sistema di fissaggio.

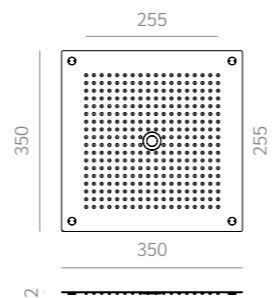

LUMINA / WT20C1

NEW



Body: Ceiling mounted recessed round showerhead
 Ø200 mm.
Water-pattern: 1 rain jet included 1 spotlight led with white lights.
 Complete with fixing system
N.B. To be teamed with systems to manage hydraulic and electric part.

Descrizione: Soffione tondo da incasso Ø 200 mm
Funzione: 1 getto pioggia incluso faretto led con luci bianche.
 Completo di sistema di fissaggio.
N.B. da abbinare a sistemi per gestione idraulica ed elettrica

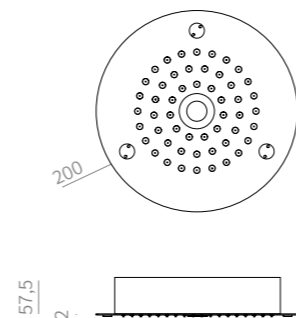

SHOWERHEADS

/ SOFFIONI

ESSENTIA

ALL THE ESSENTIAL IN A SINGLE PRODUCT.
TUTTO L'ESSENZIALE IN UN UNICO PRODOTTO.

The Essentia series wants to go back to the origins of our inspiration, water. The jet is freed from any complementary device, going back to the simple beneficial purity of the liquid touch on our skin. In the form of rain, waterfall or steam cloud, the jet is diversified and calibrated according to the specific needs of body and mind.

La serie Essentia vuole ritornare alle origini della nostra ispirazione, l'acqua. Il getto viene liberato da qualsiasi strumentazione complementare, ritornando alla semplice purezza benefica del tocco liquido sulla nostra pelle. In forma di pioggia, di cascata o di nuvola di vapore, il getto viene diversificato e calibrato a seconda delle specifiche necessità del corpo e della mente.

FEATURES**7 jets available**

Seven different nozzles, making water jets able to guarantee a wide range of sensations and emotions.

Silicone nozzles

The modules are made of descaling liquid silicone, certified for food use.

Large wetting surface

One of the widest wetting surfaces on the market, in proportion to the extension of the showerhead.

Available for wall-mounted use

It is also possible to install the Essentia series on the wall, by means of a shower arm.

CARATTERISTICHE**7 getti disponibili**

Sette ugelli differenti, per getti d'acqua capaci di garantire una vasta gamma di sensazioni ed emozioni.

Ugelli in silicone

I moduli sono creati in silicone liquido anticalcare, omologato per utilizzo alimentare.

Ampia superficie bagnata

Una delle superfici bagnanti più ampie sul mercato, in proporzione all'estensione del soffione.

Disponibile anche da parete

È inoltre possibile installare la serie Essentia a parete, tramite l'inserimento di un braccio.

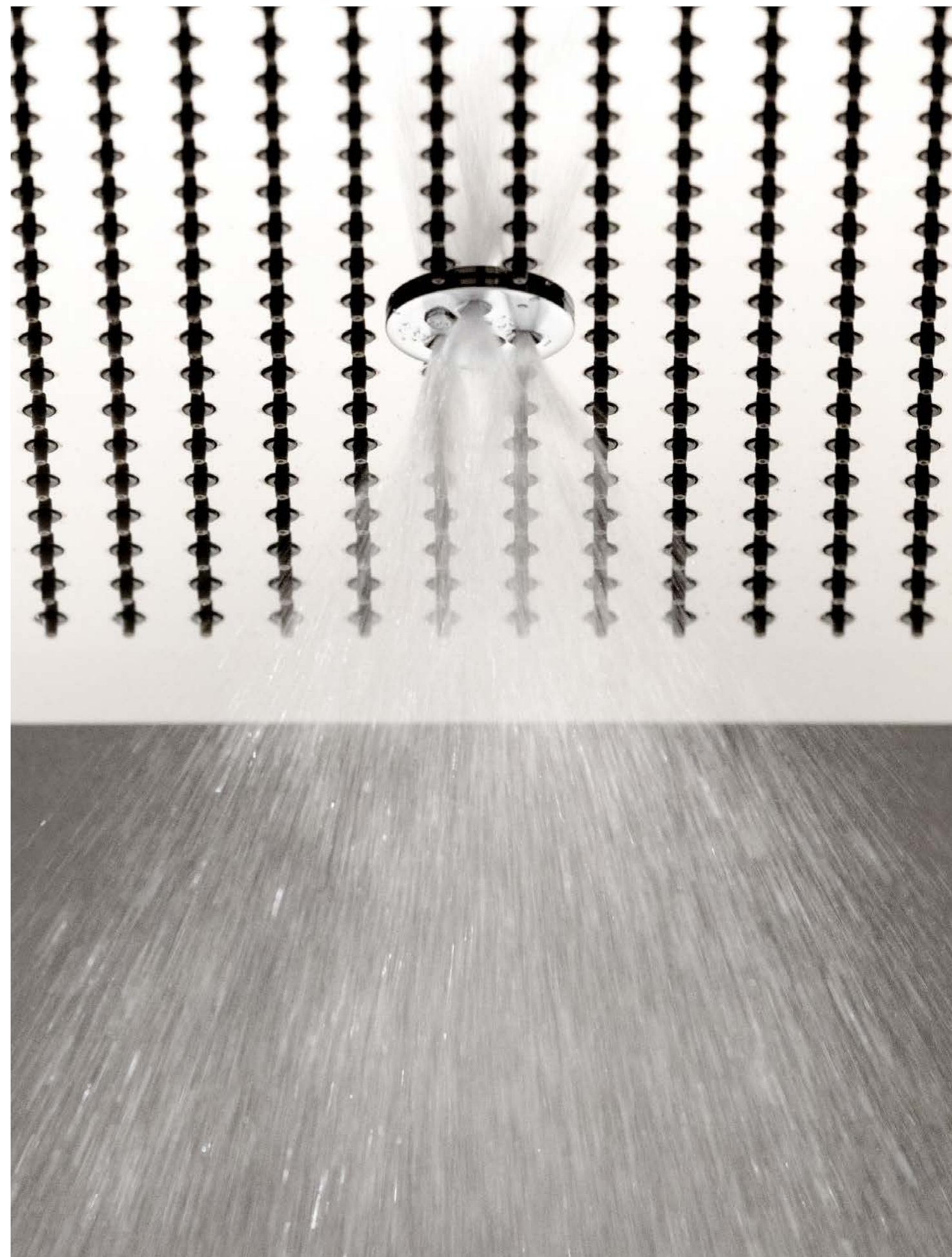



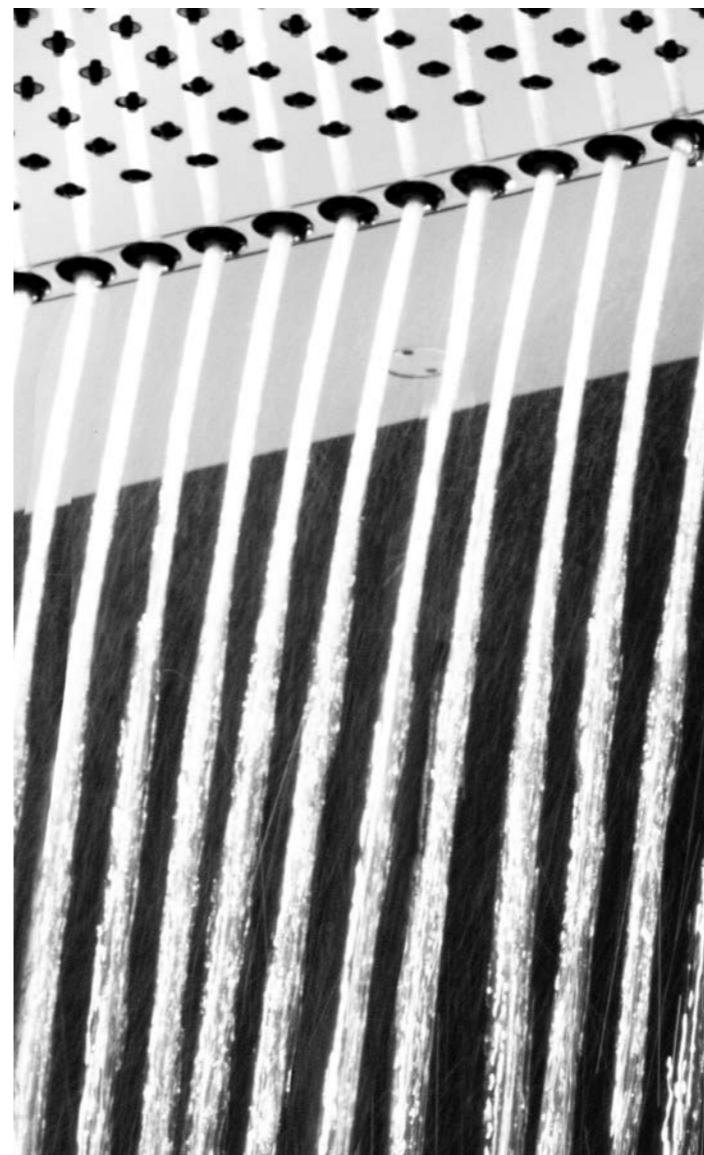

ESSENTIA / N70C1234

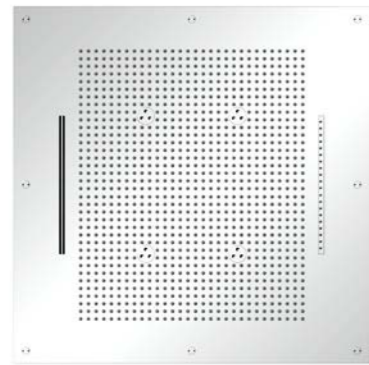

Body: 700X700 mm square recessed shower head.
Function: Rain jet, waterfall, 4 nebulized, 1 tropical.
Wet surface: 435x525mm.
Recessed: 100 mm.
 Complete with fixing system.

Corpo: Soffione quadro da incasso 700X700 mm.
Funzione: Getto pioggia, cascata, 4 nebulizzati, 1 tropicale.
Superficie bagnata: 435x525mm.
Incasso: 100 mm.
 Completo di sistema di fissaggio.

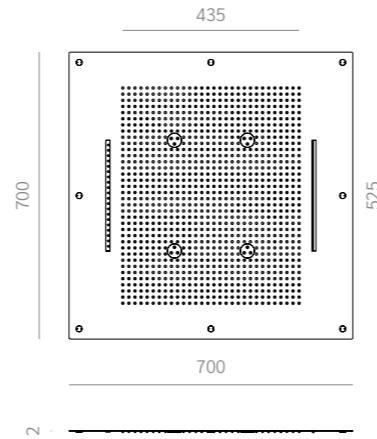

ESSENTIA / N70C1

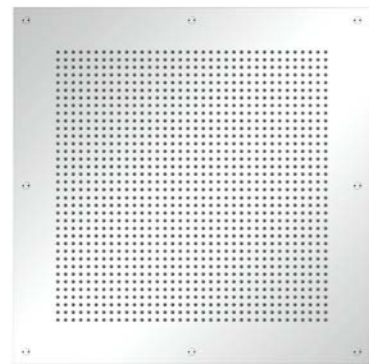

Body: 700x700 mm square recessed shower head.
Function: Rain jet.
Wet surface: 525x525mm.
Recessed: 100 mm.
 Complete with fixing system.

Corpo: Soffione quadro da incasso 700x700 mm.
Funzione: Getto pioggia.
Superficie bagnata: 525x525mm.
Incasso: 100 mm.
 Completo di sistema di fissaggio.

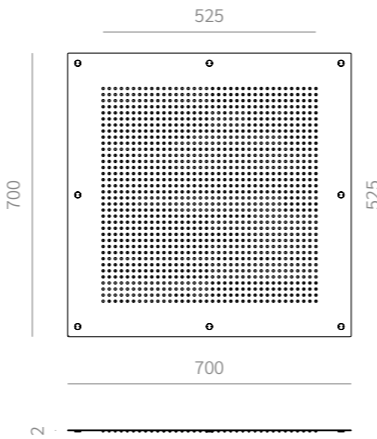

ESSENTIA / N7048C124

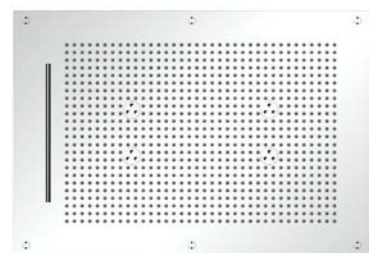

Body: 700x480 mm rectangular recessed shower head.
Function: Rain jet, waterfall and nebulized.
Wet surface: 525x345mm.
Recessed: 100 mm.
 Complete with fixing system.

Corpo: Soffione rettangolare da incasso 700x480 mm.
Funzione: Getto pioggia, cascata e nebulizzato.
Superficie bagnata: 525x345mm.
Incasso: 100 mm.
 Completo di sistema di fissaggio.

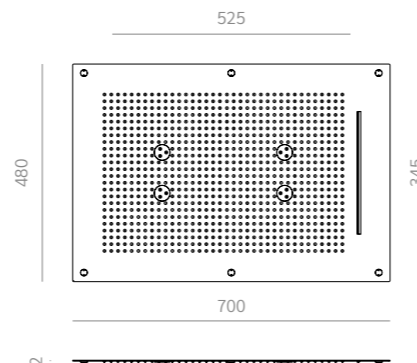

ESSENTIA / N7048C12

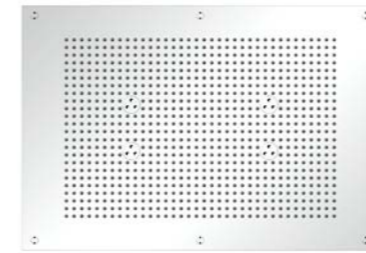

Body: 700x480 mm rectangular recessed shower head.
Function: Rain jet and nebulized.
Wet surface: 525x345mm.
Recessed: 100 mm.
 Complete with fixing system.

Corpo: Soffione rettangolare da incasso 700x480 mm.
Funzione: Getto pioggia e nebulizzato.
Superficie bagnata: 525x345mm.
Incasso: 100 mm.
 Completo di sistema di fissaggio.

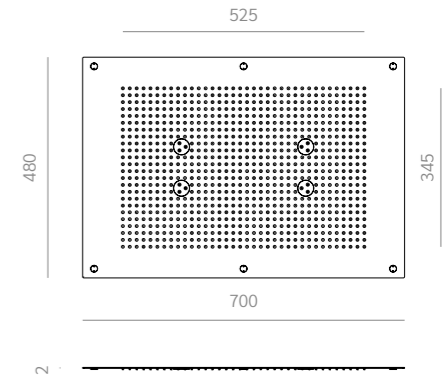

ESSENTIA / N5638C14

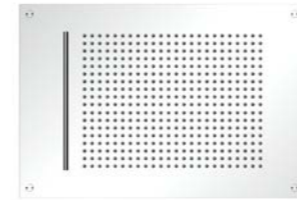

Body: 560x380 mm rectangular recessed shower head.
Function: Rain jet and waterfall.
Wet surface: 345x255mm.
Recessed: 100 mm.
 Complete with fixing system.

Corpo: Soffione rettangolare da incasso 560x380 mm.
Funzione: Getto pioggia e cascata.
Superficie bagnata: 345x255mm.
Incasso: 100 mm.
 Completo di sistema di fissaggio.

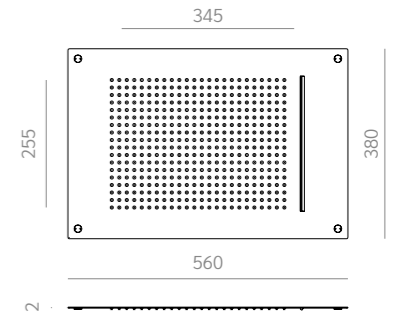

ESSENTIA / N5638C1

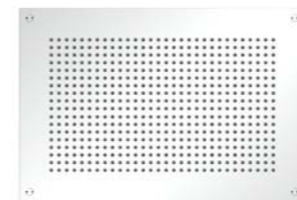

Body: 560x380 mm rectangular recessed shower head.
Function: Rain jet.
Wet surface: 435x255mm.
Recessed: 100 mm.
 Complete with fixing system.

Corpo: Soffione rettangolare da incasso 560x380 mm.
Funzione: Getto pioggia.
Superficie bagnata: 435x255mm.
Incasso: 100 mm.
 Completo di sistema di fissaggio.

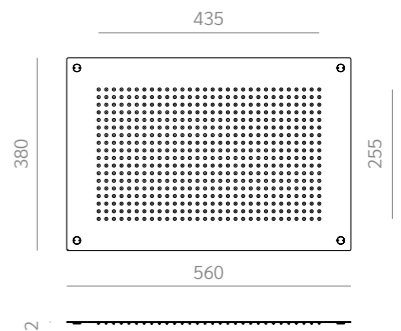

ESSENTIA / NT65C1

NEW



Body: Round recessed shower head Ø 650 mm
Functions: 1 rain jet
Recessed depth: 100 mm
Feeding: 1/2" inch
Operating pressure: 1.5 / 5 bar
Recommended pressure: 3 bar
 Complete with fixing system.
N.B. to be combined with systems for hydraulic and electrical management

Corpo: Soffione tondo da incasso Ø 650 mm
Funzioni: 1 getto pioggia
Profondità incasso: 100 mm
Alimentazione: 1/2" pollice
Pressione di esercizio: 1,5 / 5 bar
Pressione consigliata: 3 bar
 Completo di sistema di fissaggio.
N.B. da abbinare a sistemi per gestione idraulica ed elettrica

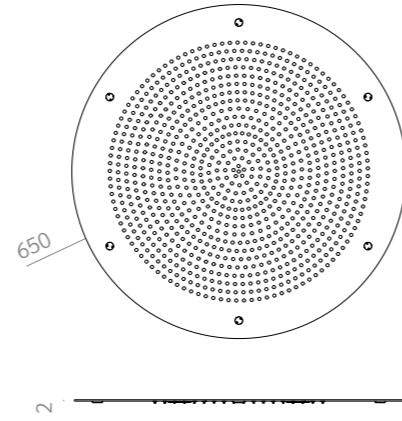

ESSENTIA / N42C124

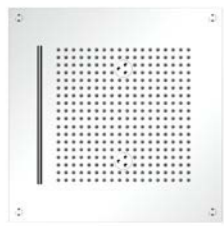

Body: 420x420 mm square recessed shower head.
Function: Rain jet, 2 nebulized and waterfall.
Wet surface: 255x255mm.
Recessed: 100 mm.
 Complete with fixing system.

Corpo: Soffione quadro da incasso 420x420 mm.
Funzione: Getto pioggia, 2 nebulizzati e cascata.
Superficie bagnata: 255x255mm.
Incasso: 100 mm.
 Completo di sistema di fissaggio.

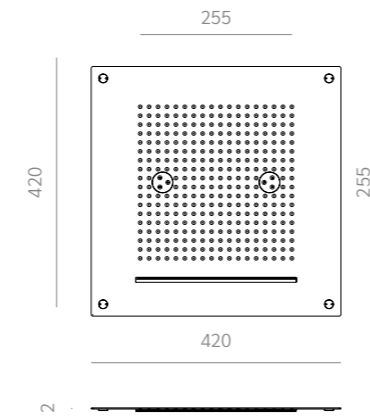

ESSENTIA / N35C12

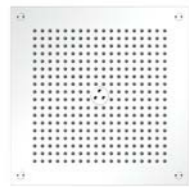

Body: 350x350 mm square recessed shower head.
Function: Rain jet and 1 nebulized.
Wet surface: 255x255mm.
Recessed: 100 mm.

Corpo: Soffione quadro da incasso 350x350 mm.
Funzione: Getto pioggia e 1 nebulizzato.
Superficie bagnata: 255x255mm.
Incasso: 100 mm.

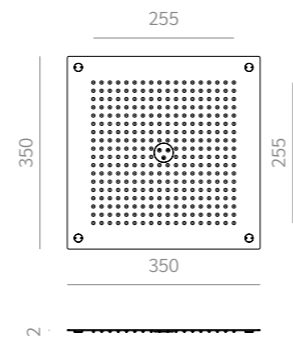

ESSENTIA / N35C1

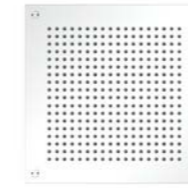

Body: 350x350 mm square recessed shower head.
Function: Rain jet.
Wet surface: 255x255mm.
Recessed: 100 mm.

Corpo: Soffione quadro da incasso 350x350 mm.
Funzione: Getto pioggia.
Superficie bagnata: 255x255mm.
Incasso: 100 mm.

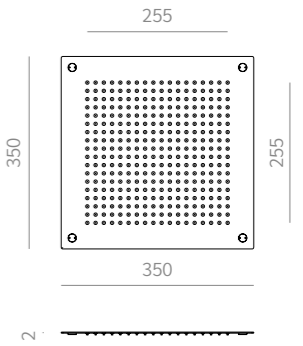

ESSENTIA / NT28C1

NEW



Body: Ø 280 mm round recessed and wall shower head.
Function: Rain jet.
Wet surface: Ø 270 mm.
 Complete with fixing system.

Corpo: Soffione tondo da incasso e parete Ø 280 mm.
Funzione: Getto pioggia.
Superficie bagnata: Ø 270 mm.
 Completo di sistema di fissaggio.

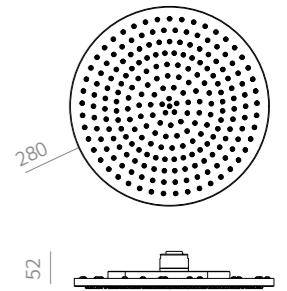

ESSENTIA / N30C1

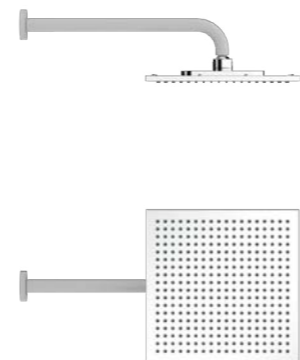

Body: 300x300 mm square recessed and wall shower head.
Function: Rain jet.
Wet surface: 255x255mm.

Corpo: Soffione quadro da incasso e parete 300x300 mm.
Funzione: Getto pioggia.
Superficie bagnata: 255x255mm.

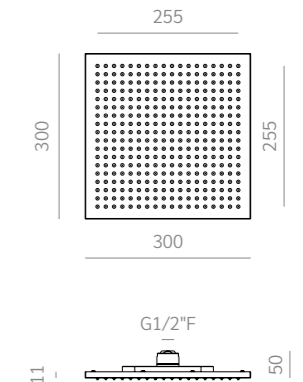

CONTROLS

/ CONTROLLI



To manage the various functions more easily, we have chosen to equip our products with controls, different in type and scope, able to ensure a high performance.

Touch controls include the full range of shower functions for a highly personalized experience.

The push-button panels use pre-set and adjustable programs, in a perfect balance between practicality and convenience.

The manual controls operate the selection of temperature and jet, for a more classic experience.

Per facilitare la gestione dei nostri prodotti, grazie alla consulenza e agli studi tecnici di specialisti, abbiamo scelto di dotare i nostri prodotti di controlli, diversi per tipologia e funzioni, in grado di garantire elevate prestazioni e ampia varietà.

I comandi touch includono l'intera gamma di funzioni doccia, per un'esperienza altamente personalizzata.

Le pulsantiere utilizzano programmi preimpostati e modificabili, in un perfetto equilibrio tra praticità e convenienza.

I comandi manuali agiscono sulla selezione della temperatura e del getto, per un'esperienza più classica.



PROFESSIONAL SYSTEMS

/ Sistemi professionali

R70C1234 + P600

Professional control unit for sequential activation via single button of the experience shower. Possibility to set different parameters by selecting: times, sequence of jets, RGB lights, water temperature via electronic mixer. Possibility to manage the optional aromatherapy and music.

Centralina professionale per l'attivazione sequenziale tramite singolo pulsante della doccia emozionale. Possibilità di impostare diversi parametri selezionando: tempi, sequenza dei getti, luci RGB, temperatura dell'acqua tramite miscelatore elettronico. Possibilità di gestire gli optional di aromaterapia e musica.

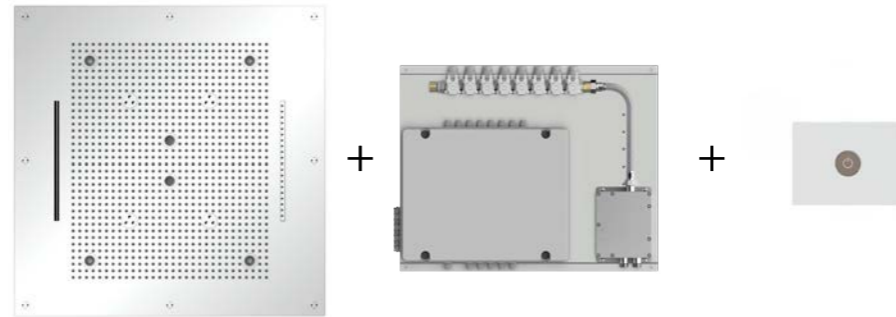

R70C1234 + P450 + GTQ1

Professional control unit for sequential activation via a single button of the emotional shower. Possibility to set different parameters by selecting: times, sequence of jets, RGB lights. Possibility to manage the optional aromatherapy and music. Temperature management through manual thermostatic.

Centralina professionale per l'attivazione sequenziale tramite singolo pulsante della doccia emozionale. Possibilità di impostare diversi parametri selezionando: tempi, sequenza dei getti, luci RGB. Possibilità di gestire gli optional di aromaterapia e musica. Gestione della temperatura tramite termostatico manuale.

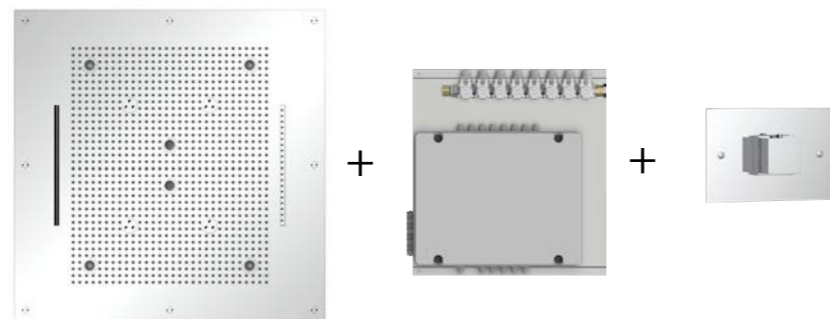

R70C1234 + C48FX

Control unit for 4 different pre-set programs to achieve 4 different treatment cycles: energy-balance -sport and relaxation.

Centralina di controllo per 4 differenti programmi pre-impostati per ottenere 4 diversi cicli di trattamento: energy- balance -sport e relax.

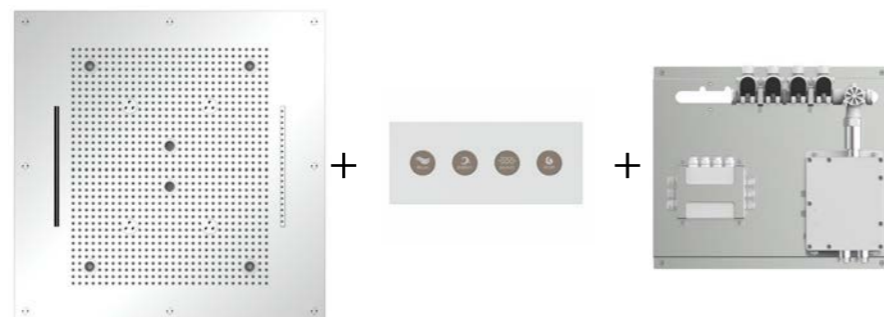

R70C1234 + C48PRO + GTQ1

Professional control unit for the activation of 4 different customizable scenarios. Possibility to set the parameters of water and RGB + W light in timed or on / off mode. Possibility to manage the optional aromatherapy and music. Flush-mounted stainless steel keyboard with 4 buttons for activation of different scenarios. Temperature management through manual thermostatic.

Centralina di controllo professionale per l'attivazione di 4 differenti scenari personalizzabili. Possibilità di impostare i parametri di acqua e luce RGB+W in modalità temporizzata o on/off. Possibilità di gestire gli optional di aromaterapia e musica. Tastiera da incasso in acciaio inox filo muro con 4 pulsanti per l'attivazione dei diversi scenari. Gestione della temperatura tramite termostatico manuale.

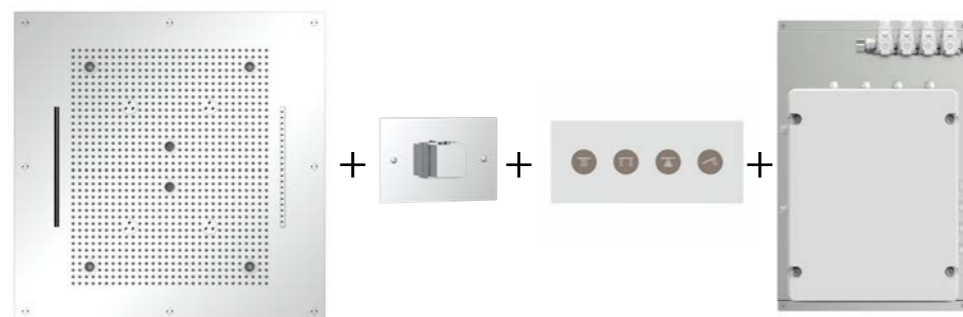

PRIVATE SYSTEMS

/ Sistemi privati

R70C1234 + C60 + V100

4.3" touch screen keyboard with possibility to control and customize all the functions of the experience shower with a single interface. Possibility to manage up to 6 output ways by solenoid valves. Activation of the jets, management of the flow rate and water temperature via electronic mixer. Chromotherapy and dry aromatherapy. Integrated radio and Bluetooth.

Tastiera touch screen da 4,3" con la possibilità di controllare e personalizzare tutte le funzioni della doccia emozionale tramite un'unica interfaccia. Possibilità di gestire fino a 6 vie d'uscita tramite elettrovalvole. Attivazione dei getti, gestione della portata e temperatura dell'acqua tramite miscelatore elettronico. Cromoterapia e aromaterapia a secco. Radio e Bluetooth integrato.

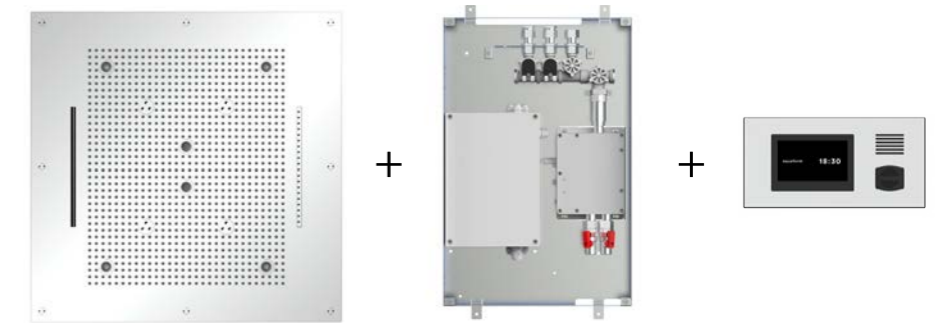

R70C1234 + C48 + C30 + GTQ1

Paired push-button panels in stainless steel for on / off management of water jets and independent control of chromotherapy and aromatherapy. Manual thermostatic for temperature management.

Pulsantiera in coppia in acciaio inox filo muro per la gestione on/off dei getti d'acqua e controllo indipendente di cromoterapia e aromaterapia. Termostatico manuale per la gestione della temperatura.

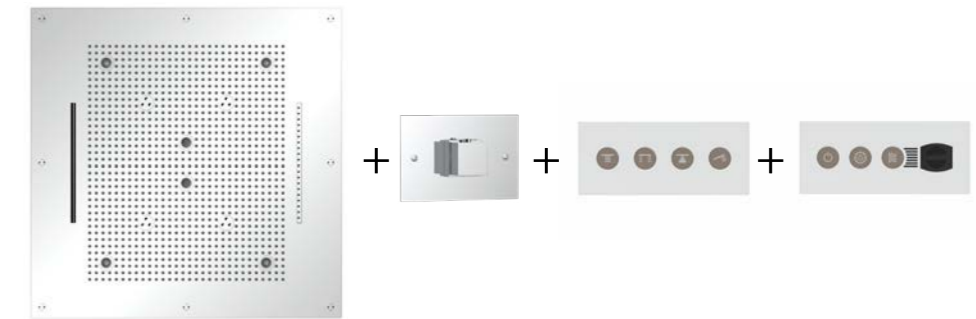

R70C1234 + GTQ4C + C70

Thermostatic diverter for water flow rate and temperature setting combined with touch keyboard for RGB lights.

Deviatore termostatico per la gestione dell'acqua e della sua temperatura da abbinare a tastiera touch per la gestione della luci RGB.

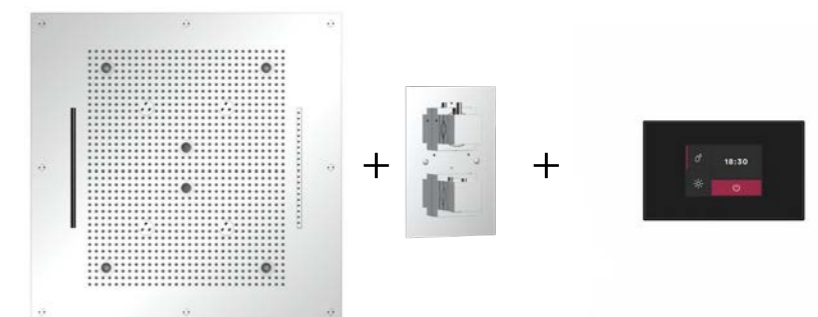

R70C1234 + C75 + A30 + GTQ1

3.5" touch screen keyboard with the possibility to control and customize all the functions of the experience shower. Possibility to manage up to 4 output ways through solenoid valves. Activation of the jets. Chromotherapy. Optional aromatherapy via separate diffuser. Temperature management through manual thermostatic.

Tastiera touch screen da 3,5" con la possibilità di controllare e personalizzare le funzioni della doccia emozionale. Possibilità di gestire fino a 4 vie d'uscita tramite elettrovalvole. Attivazione dei getti. Cromoterapia. Aromaterapia opzionale tramite diffusore separato. Gestione della temperatura tramite termostatico manuale.

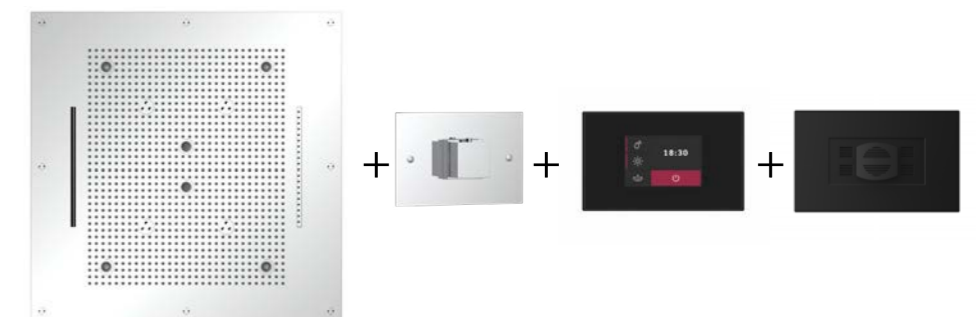

CONTROLS

CONTROLLI

The water management system is the showpiece of aquaform production.

Il sistema di gestione delle acque è il fiore all'occhiello della produzione aquaform.

aquaform developed many different management systems (push, touch and manual), each with different functions, therefore we can offer a product able to combine high performance with easy and intuitive management.

aquaform ha sviluppato molti sistemi di gestione diversi (push, touch e manual), ognuno con funzionalità diverse, realizzati per offrire un prodotto in grado di coniugare alte prestazioni con una gestione facile e intuitiva.

C10

on/off white lights

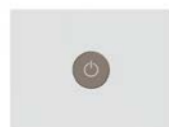

C20

chromotherapy



C30

chromotherapy + aromatherapy



C45

on/off jet

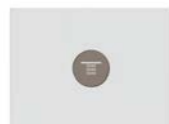

C46

on/off 2 jets



C47

on/off 3 jets

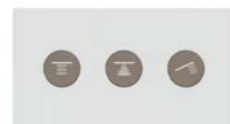

C48

on/off 4 jets

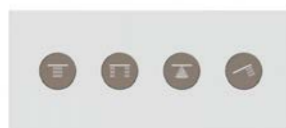

C48FX

4 pre-set programs



C55 - Touch



C60 - Touch



C70 - Touch

NEW



C75 - Touch

NEW

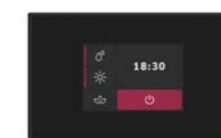

GTQ SERIES

Thermostatic mixer with diverter



GTT SERIES

Thermostatic mixer with diverter



GTQ1

Thermostatic mixer



A30 - Aroma



A10 - Aroma



BODYJET

/ BODYJET

Aquaform body jets can be integrated in any context and fulfill different functions and use configurations. The jets with the integrated RGB LED spotlight can be used for our Kneipp path and reaction shower, the massaging body jets can be used as a vertical massage shower.

I body jet aquaform possono essere inseriti in qualunque contesto e assumere diverse funzioni e configurazioni di utilizzo, i getti con il faretto led RGB integrato possono essere utilizzati per il nostro percorso kneipp e la doccia di reazione, i body jet massaggianti possono essere invece utilizzati come una doccia verticale massaggiante

BL85C1



Round wall mounted body jet in chrome-plated brass with 1 rain jet and RGB LED for chromotherapy.

Body jet tondo da incasso in ottone cromato con 1 getto pioggia e Led RGB per cromoterapia.



BL85C2



Round wall mounted body jet in chrome-plated brass with 1 nebulized jet and RGB LED for chromotherapy.

Body jet tondo da incasso in ottone cromato con 1 getto nebulizzato e Led RGB per cromoterapia.



BL85C6



Round wall mounted body jet in chrome-plated brass with 1 atomized jet and RGB LED for chromotherapy.

Body jet tondo da incasso in ottone cromato con 1 getto atomizzato e Led RGB per cromoterapia.



PTRC

NEW



Water connection in chromed brass complete kit with tap, flex and hand shower.

Attacco acqua in ottone cromato kit completo di rubinetto, flessibile e doccia.



BT75C123

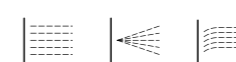

Round wall mounted body jet, in chrome-plated brass with 3 functions rain jet, nebulized jet, tropical jet.

Body jet tondo da incasso, in ottone cromato 3 funzioni getto pioggia, nebulizzato, getto tropicale.



BQ50C2



Square wall mounted body jet, in chrome-plated brass 1 jet nebulized.

Body jet quadro da incasso, in ottone cromato 1 getto nebulizzato.



BQ75C1



Recessed square body jet, in chrome-plated brass 1 rain jet.

Body jet quadro da incasso, in ottone cromato 1 getto pioggia.



BT50C2



Round wall mounted body jet, in chrome-plated brass 1 jet nebulized.

Body jet tondo da incasso, in ottone cromato 1 getto nebulizzato.



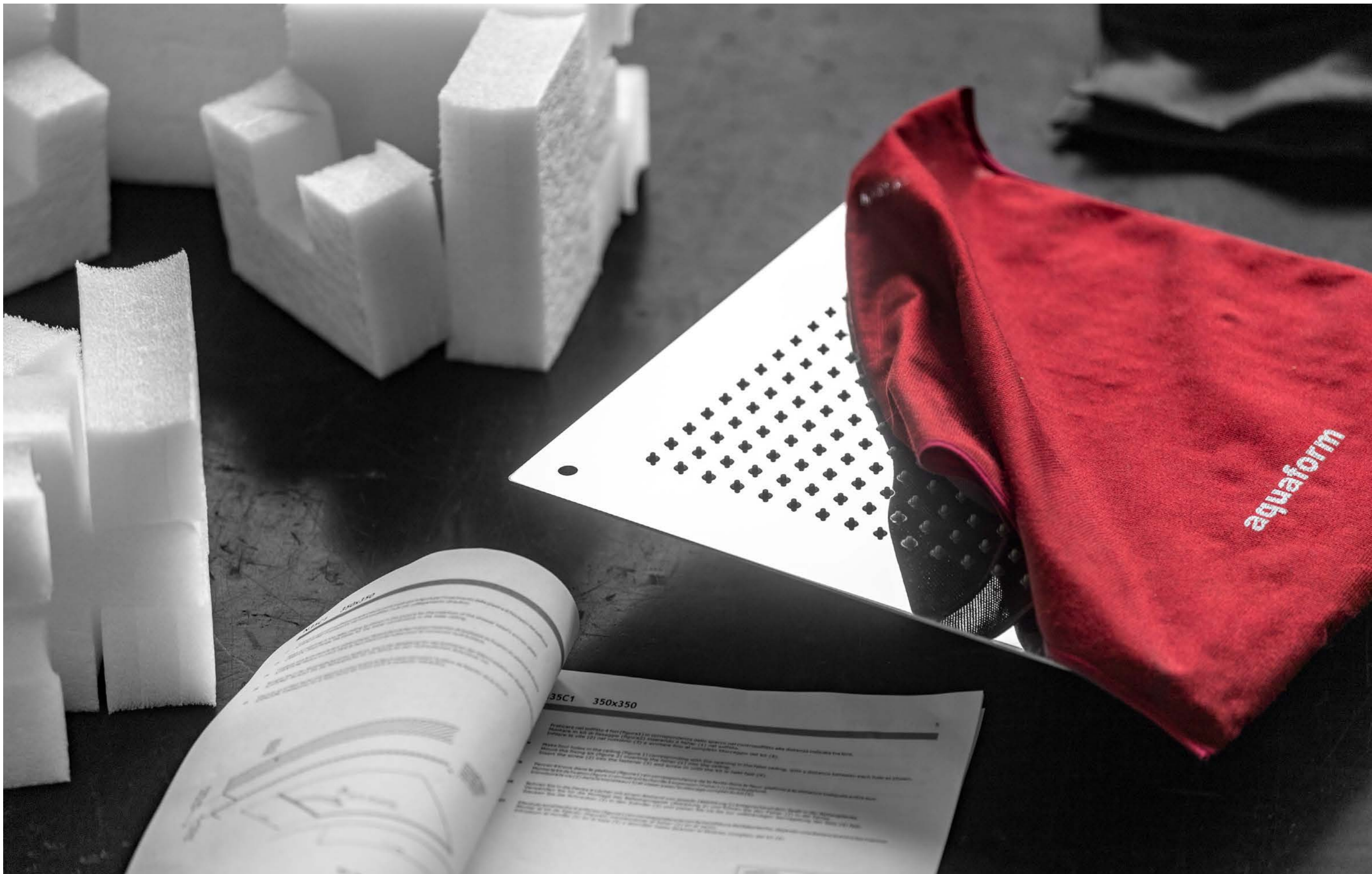

ART DIRECTION
Federico Castelli Design

PHOTO
Ottavio Tomasini

PRINT
Intese Grafiche

PARTNER
The logo for bbpa, featuring the lowercase letters 'bbpa' in a bold, sans-serif font. The 'b's are dark red, and the 'p's are a lighter red. Above the 'pa' part, the text 'b.b.p.a.' is written in a smaller, dark red font.

Aquaform Srl Unipersonale

Via Matteotti, 311, 25063 Gardone Val Trompia (BS)

t. +39 0308913122

www.aquaformsrl.com